



AC/DC

PV

ISOMETER® isoPV1685RTU

Insulation monitoring device for unearthed photovoltaic systems

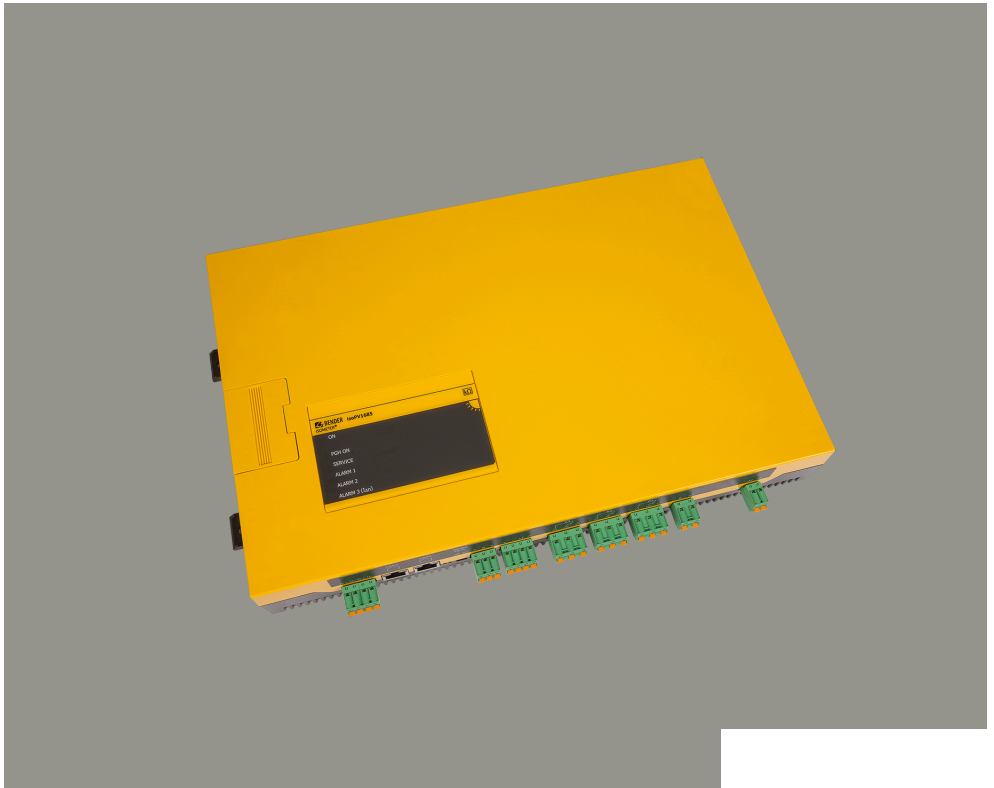

Table of contents

1	General information.....	5
1.1	How to use the manual.....	5
1.2	Indication of important instructions and information.....	5
1.3	Service and Support.....	5
1.4	Training courses and seminars.....	5
1.5	Delivery conditions.....	5
1.6	Inspection, transport and storage.....	6
1.7	Warranty and liability.....	6
1.8	Disposal of Bender devices.....	6
1.9	Safety.....	7
2	Function.....	8
2.1	Intended use.....	8
2.2	Product description.....	8
2.3	Device features.....	8
2.4	History memory.....	9
2.5	Self test after connection to the supply voltage.....	10
2.5.1	Automatic self test during operation.....	10
2.5.2	Manual self test during operation.....	10
3	Device overview.....	11
3.1	Dimensions.....	11
3.2	Terminals.....	12
3.3	Display and operating elements.....	13
4	Mounting.....	15
5	Connection.....	16
6	Commissioning.....	19
6.1	Commissioning diagram.....	19
7	Settings.....	20
7.1	Set alarm for insulation fault.....	20
7.2	Set measuring speed.....	20
7.3	Parameter setting of the insulation fault location.....	21
7.4	Deactivate device.....	22
7.5	Resetting alarm messages.....	22
7.6	Parameterisation with the "iso1685 Set" software.....	22

8	Device communication.....	23
8.1	RS-485 interface.....	23
8.2	BMS protocol.....	25
8.2.1	Set BMS addresses.....	25
8.2.2	Messages via the BMS bus.....	26
8.3	Modbus RTU protocol.....	28
9	Technical data.....	29
9.1	Diagrams.....	29
9.2	Factory settings.....	30
9.3	Tabular data isoPV1685RTU.....	30
9.4	Standards and approvals.....	34
9.5	Ordering details.....	34

1 General information

1.1 How to use the manual

**ADVICE**

This manual is intended for qualified personnel working in electrical engineering and electronics! Part of the device documentation in addition to this manual is the enclosed supplement 'Safety instructions for Bender products'.

**ADVICE**

Read the operating manual before mounting, connecting and commissioning the device. Keep the manual within easy reach for future reference.

1.2 Indication of important instructions and information

**DANGER**

Indicates a high risk of danger that will result in death or serious injury if not avoided.

**WARNING**

Indicates a medium risk of danger that can lead to death or serious injury if not avoided.

**CAUTION**

Indicates a low-level risk that can result in minor or moderate injury or damage to property if not avoided.

**ADVICE**

Indicates important facts that do not result in immediate injuries. They can lead to malfunctions if the device is handled incorrectly.



Information can help to optimise the use of the product.

1.3 Service and Support

Information and contact details about customer service, repair service or field service for Bender devices are available on the following website: Fast assistance | Bender GmbH & Co. KG.

1.4 Training courses and seminars

Regular face-to-face or online seminars for customers and other interested parties:

www.bender.de > know-how > seminars.

1.5 Delivery conditions

The conditions of sale and delivery set out by Bender GmbH & Co. KG apply. These can be obtained in printed or electronic format.

1.6 Inspection, transport and storage

Check the shipping and device packaging for transport damage and scope of delivery. In the event of complaints, the company must be notified immediately, see 'www.bender.de > service & support.'

When storing the devices, observe the information under Environment / EMC in the technical data.

1.7 Warranty and liability

Warranty and liability claims for personal injury and property damage are excluded in the case of:

- Improper use of the device.
- Incorrect mounting, commissioning, operation and maintenance of the device.
- Failure to observe the instructions in this operating manual regarding transport, commissioning, operation and maintenance of the device.
- Unauthorised changes to the device made by parties other than the manufacturer.
- Non-observance of technical data.
- Repairs carried out incorrectly.
- The use of accessories or spare parts that are not provided, approved or recommended by the manufacturer.
- Catastrophes caused by external influences and force majeure.
- Mounting and installation with device combinations not approved or recommended by the manufacturer.

This operating manual and the enclosed safety instructions must be observed by all persons working with the device. Furthermore, the rules and regulations that apply for accident prevention at the place of use must be observed.

1.8 Disposal of Bender devices

Abide by the national regulations and laws governing the disposal of this device.



Bender GmbH & Co. KG is registered in the waste from electrical and electronic equipment (WEEE) register under the WEEE number: DE 43 124 402. For more information on the disposal of Bender devices, refer to www.bender.de > service & support.

1.9 Safety

If the device is used outside the Federal Republic of Germany, the applicable local standards and regulations must be complied with. In Europe, the European standard EN 50110 applies.



DANGER Risk of fatal injury due to electric shock!

Touching live parts of the system carries the risk of:

- Risk of electrocution due to electric shock
- Damage to the electrical installation
- Destruction of the device

Before installing the device and before working on its connections, make sure that the installation has been de-energised. The rules for working on electrical systems must be observed.

2 Function

2.1 Intended use

The device isoPV1685RTU is used for insulation monitoring of large photovoltaic systems up to DC 1500 V designed as IT systems. The measurement method specially developed for slow voltage fluctuations (MPP tracking) monitors the insulation resistance even in systems equipped with large solar generator panels where extremely high system leakage capacitances against earth exist due to interference suppression methods. Adaptation to system-related high leakage capacitances also occurs automatically within the selected profile.

In order to meet the requirements of the applicable standards, customised parameter settings must be made on the equipment in order to adapt it to local equipment and operating conditions. Please heed the limits of the range of application indicated in the technical data.

Intended use also includes

- the observation of all information in the operating manual and
- compliance with the test intervals in accordance with the relevant standards and operating rules.

Caution: This equipment is not intended for use in residential environments and may not provide adequate protection to radio reception in such environments.

Do not make any unauthorised changes to the device. Only use spare parts and optional accessories sold or recommended by the manufacturer.

Any other use than that described in this manual is regarded as improper.

2.2 Product description

The ISOMETER® isoPV1685RTU is an insulation monitoring device for IT systems according to IEC 61557-8 . It can be used in photovoltaic systems. Please refer to the technical data for the exact device specification.

The measurement method especially developed for this purpose monitors the insulation resistance even in installations where extremely high system leakage capacitances against earth exist due to interference suppression methods. The adaptation even to system-related high leakage capacitances is automatic.

2.3 Device features

ISOMETER® for photovoltaic systems.

- Insulation monitoring of large PV systems
- Measurement of insulation faults 200 Ω...1 MΩ
- Automatic adjustment to high system leakage capacitances
- Combination of **AMPPLUS** and other profile-specific measurement methods
- Separately adjustable response values R_{an1} (Alarm 1) and R_{an2} (Alarm 2) for prewarning and alarm
- Connection monitoring E/KE
- Connection monitoring of L+, L- for polarity reversal
- Device self test with automatic alarm message in the event of a fault
- µSD card (not equipped) with data logger and history memory for alarms
- Digital inputs
- Separate relays for insulation fault 1, insulation fault 2 and device error

Interfaces

- RS-485 interface for data exchange with other Bender devices
- BMS and Modbus RTU protocol via RS-485 interface, switchable
- Modbus RTU via RS-485 interface

Insulation monitoring is carried out using an active measuring pulse which is superimposed onto the IT system to earth via the integrated coupling. If the insulation resistance between a PV system and earth falls below the set prewarning response value R_{an1} , the LED **ALARM 1** lights up and relay **K1** switches. If the insulation resistance falls below the alarm response value R_{an2} , the LED **ALARM 2** lights up and the alarm relay **K2** switches. The relay **K3** switches in case of device or connection failures.

i

Installation inside a control cabinet

If the ISOMETER® is installed inside a control cabinet, the insulation fault message must be audible and/or visible to attract attention.

IT systems with several ISOMETER®s

Only one ISOMETER® may be connected in a galvanically connected system. In IT systems that are interconnected via tie switches, ISOMETER®s that are not required must be disconnected from the IT system or switched to inactive.

If IT systems are coupled via capacitors or diodes, a central control of the various ISOMETER® must be used.

Prevent measurement errors!

In galvanically coupled DC circuits, an insulation fault can only be detected correctly if a minimum current of > 10 mA flows through the rectifiers.

Unspecified frequency range

Depending on the application and the selected measurement profile, continuous insulation monitoring is also possible in low frequency ranges. For IT systems with frequency components above the specified frequency range, there is no influence on the insulation monitoring.

2.4 History memory

All warnings, alarms and device errors are time-stamped and stored in the device's internal history memory. The times of the start, acknowledgement and end of the event are recorded.

History data

The history data are copied from the internal EEPROM to the History.csv file on the µSD card under the following conditions:

- After device start-up
- During operation once per hour
- When a compatible µSD card has been inserted

For the evaluation of the history memory, the Excel tool "iso1685 History.xlsx" can be provided. This tool allows .csv file data to be processed and evaluated.

Example: Alarm data record in the history memory

Parameter	Value	Description
Index	Idx 231	Index history memory
ID	ID43	ID of the entry
Alarm	Insulation fault	Alarm type
Min	< 200	Minimum alarm value

Max	= 200	Maximum alarm value
Unit		Unit
Test	None	Alarm during test
Start Time	27.04.12 13:59	Start time of the alarm
Ack. Time		Time of acknowledgement
Stop Time	27.04.12 13:59	End time of the alarm

2.5 Self test after connection to the supply voltage

Once connected to the supply voltage, the device checks all internal measurement functions, the components of the process control such as data and parameter memory as well as the connections to earth.

Once the self test is finished, after approx. 5 seconds. The alarm relays (**K1**, **K2**) are not switched during start-up. Afterwards, the normal measuring operation starts.

If a device or connection error is detected, the corresponding alarm is output via the integrated interfaces as well as via the alarm relay **K3**. This relay operates permanently in NC operation, i.e. a device fault is signaled even in the event of a complete failure of the device.

2.5.1 Automatic self test during operation

All internal supply voltages are continuously monitored. The following tests are continuously carried out in the background:

- Connection E-KE
- Temperature monitoring of the coupling
- Reverse polarity of mains with DC coupling
- Measuring voltage generator

A self test is automatically run at 24-hour intervals.

During the automatic self test, the alarm relays **K1** and **K2** are not switched. **K3** will *not* be switched either.

2.5.2 Manual self test during operation

The self test is started via the RS-485 interface.

The manual self-test checks:

- Internal flash
- Internal RAM
- CPU register
- Watchdogs
- Oscillator
- Function of the Iso measurement equipment
- Restart of the device including re-initialisation, recalibration and switching of all alarm relays



ADVICE

Perform a manual self-test via the interface at regular intervals specified by the operator to ensure that the device is operating correctly.

3 Device overview

3.1 Dimensions

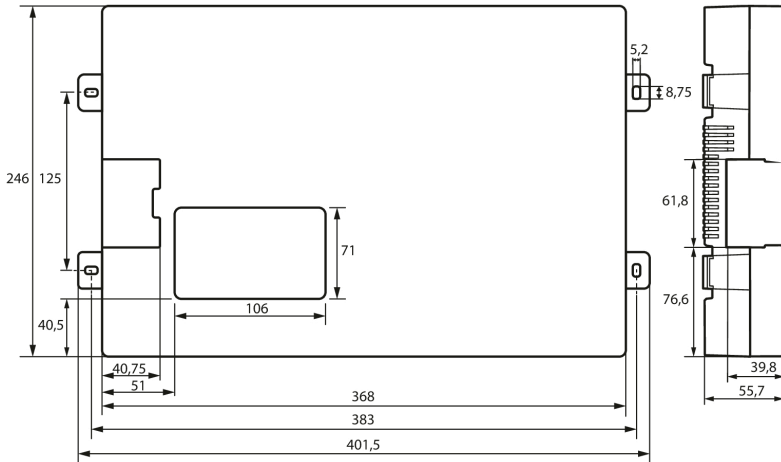

Figure: Dimensions in mm

3.2 Terminals

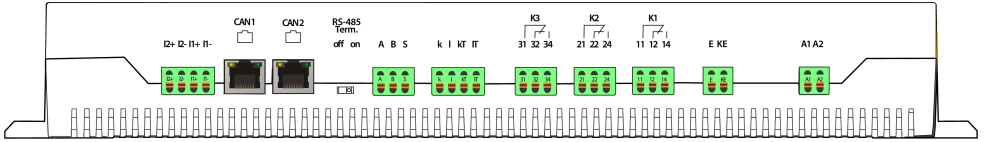

Figure 3-1: Terminals from below

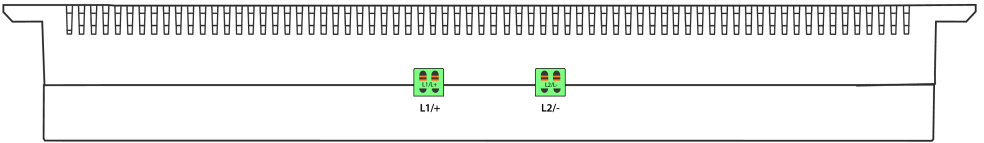

Figure 3-2: Terminals from above

View from below	
I2+, I2-	Digital input: Reset / (Memory)
I1+, I1-	Digital input: <i>Test</i> (Signal ≤ 1.5 s), <i>Standby</i> (Signal > 1.5 s) starts manual self test
CAN1, CAN2	No function
RS485 Term. off / on	RS-485 termination
A, B, S	RS-485 bus connection (A, B) BMS protocol: PE potential, connect one end of shield (S)
k, l, kT, IT	no function
31, 32, 34	Relay output for internal device errors (LED SERVICE)
21, 22, 24	Relay output for alarm insulation faults (LED ALARM 2)
11, 12, 14	Relay output for prewarning insulation faults (LED ALARM 1)
E, KE	Separate connection of E (earth) and KE (reference) to PE.
A1, A2	Connection to supply voltage (via fuses, 2 A each)
View from above	
L1/+	Connection to L1/+ of the IT system via 1 A fuse
L2/-	Connection to L2/- of the IT system via 1 A fuse

3.3 Display and operating elements

■ ON
■ PGH ON
■ SERVICE
■ ALARM 1
■ ALARM 2
■ ALARM 3 (I _{Δn})

ON (green)	Power ON indicator: Flashes with a pulse duty factor of approx. 80 %. Device error: Lights continuously when the device stops functioning (device stopped). Software update: Flashes approx. three times faster during the firmware update than in the standard mode, update time < 4 minutes.
PGH ON (yellow)	no function
SERVICE (yellow)	When an internal device error is detected, the LED SERVICE lights up. If the LED stays lit, please check the error code list.
ALARM 1 (yellow)	<ul style="list-style-type: none"> lights (prewarning): insulation resistance is below the response value 1, $R_F < R_{an1}$ flashes: connection fault, check earth and system (L1/+, L2/-)
ALARM 2 (yellow)	<ul style="list-style-type: none"> lights (alarm): insulation resistance is below the response value 2, $R_F < R_{an2}$ flashes: connection fault, check earth and system (L1/+, L2/-)
ALARM 3 (yellow)	no function

Service lid

Access to DIP switch and to the μSD card via the service lid

Open the service lid by pressing gently on the ribbed surface and pulling the lid from the enclosure away.

After removing the lid the following settings can be carried out:

- Changing the BMS address or the Modbus address (SS8103)
- Setting the maximum leakage capacitance (SS8103)
- Changing the measurement speed (SS8103)
- Resetting alarms (ST6101)

In addition, you can access the μSD card to read out stored alarms, for example.

Operating elements in the service lid

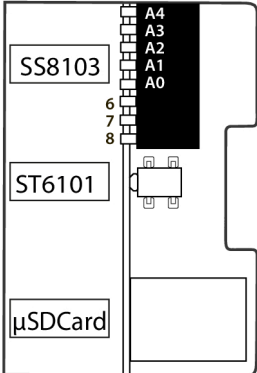
	<table border="1"> <thead> <tr> <th data-bbox="387 186 622 220">Operating elements</th> <th data-bbox="628 186 1039 220">Function</th> </tr> </thead> <tbody> <tr> <td data-bbox="387 220 622 347">DIP switch (SS8103)</td> <td data-bbox="628 220 1039 347"> <ul style="list-style-type: none"> Switching between BMS and Modbus: A4 BMS /Modbus address setting: A3...A0 Leakage capacitance setting: 6 Measurement speed setting: 7 </td> </tr> <tr> <td data-bbox="387 347 622 387">Button (ST6101)</td> <td data-bbox="628 347 1039 387">Alarm reset</td> </tr> <tr> <td data-bbox="387 387 622 576">Memory card slot (μSD card)</td> <td data-bbox="628 387 1039 576">Memory for log files and history memory</td> </tr> </tbody> </table>	Operating elements	Function	DIP switch (SS8103)	<ul style="list-style-type: none"> Switching between BMS and Modbus: A4 BMS /Modbus address setting: A3...A0 Leakage capacitance setting: 6 Measurement speed setting: 7 	Button (ST6101)	Alarm reset	Memory card slot (μSD card)	Memory for log files and history memory
Operating elements	Function								
DIP switch (SS8103)	<ul style="list-style-type: none"> Switching between BMS and Modbus: A4 BMS /Modbus address setting: A3...A0 Leakage capacitance setting: 6 Measurement speed setting: 7 								
Button (ST6101)	Alarm reset								
Memory card slot (μSD card)	Memory for log files and history memory								

4 Mounting

Mount the device using four M5 screws. Refer also to the dimension diagram where the drilling holes are illustrated. Mount the device so that the control panel can be read during operation and the mains connection is (L1/+, L2/-) positioned at the top.

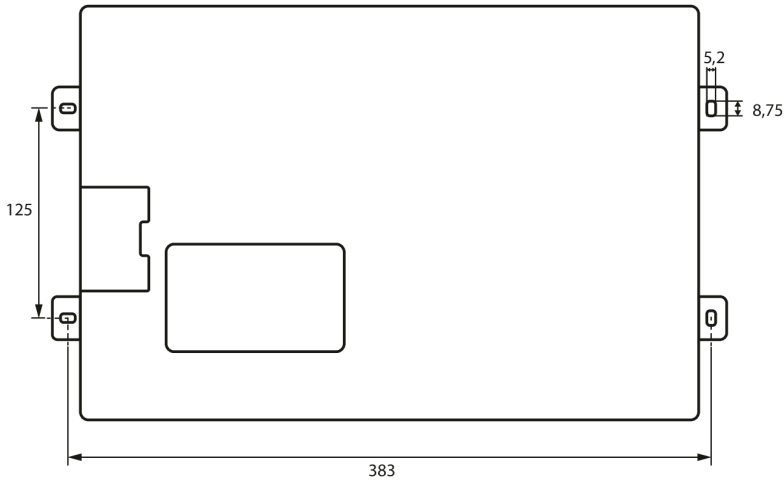

Figure 4-1: Dimensions in mm



CAUTION Damage due to unprofessional installation!

If more than one insulation monitoring device is connected to a conductively connected system, the system may be damaged. If several devices are connected, the device does not work and does not signal insulation faults.

Make sure that only one insulation monitoring device is connected.



CAUTION Heat on the enclosure surface!

The surface temperature of 60 °C can be exceeded under certain operating conditions.

Keep the cooling slots uncovered by keeping a distance of at least 15 cm above and at least 10 cm below the device to adjacent objects in order to ensure constant air circulation.



CAUTION Sharp-edged terminals!

Lacerations and injuries on hands are possible.

Touch the enclosure and the terminals with due care.

5 Connection

Connection requirements



DANGER Risk of fatal injury due to electric shock!

Touching live parts of the system carries the risk of:

- Risk of electrocution due to electric shock
- Damage to the electrical installation
- Destruction of the device

Before installing the device and before working on its connections, make sure that the installation has been de-energised. The rules for working on electrical systems must be observed.



Only skilled persons are permitted to carry out the work necessary to install, put into service and run a device or system.



ADVICE

Ensure disconnection from the IT system!

When insulation or voltage tests are to be carried out, the device must be isolated from the system for the test period. Otherwise the device may be damaged.



Pluggable push-wire terminals

All terminals are pluggable push-wire terminals. Solid connecting wires can be directly plugged in. For connection of flexible cables, the push-wire terminals must be pushed open by pressing the corresponding orange interlocking mechanism with a flat-head screwdriver. Observe the specification in the technical data.



Check proper connection!

Prior to commissioning of the installation, check that the device has been properly connected and check that the device functions.

Perform a functional test using an earth fault via a suitable resistor.

Connection diagram

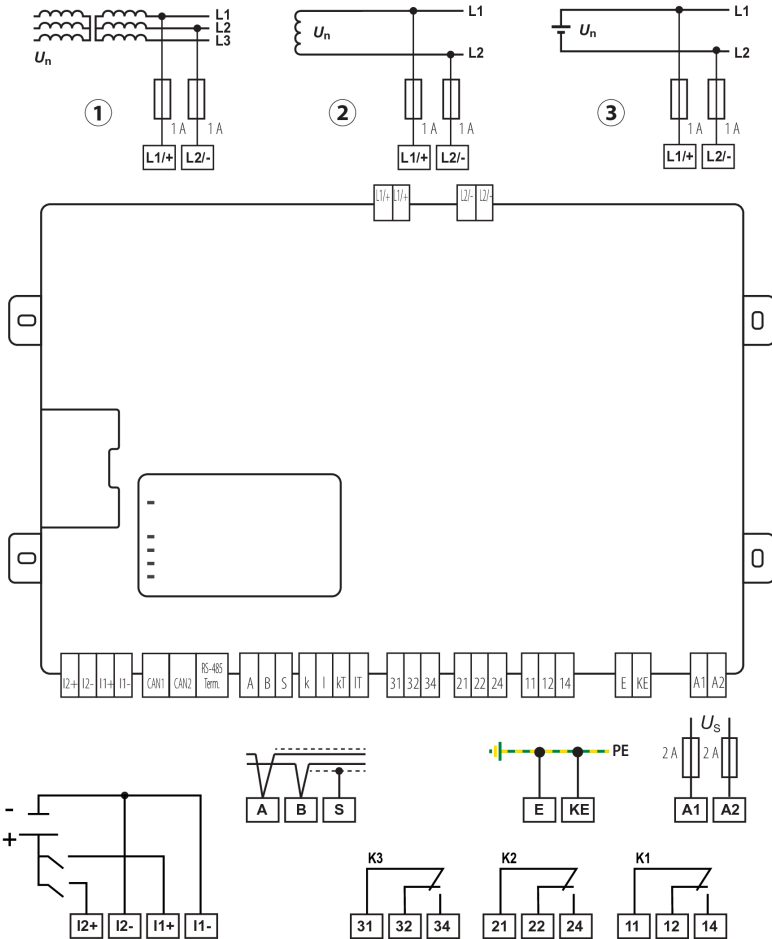

1 [L1/+, L2/-]: Connection to a 3(N)AC system

2 [L1/+, L2/-]: Connection to a AC system

3 [L1/+, L2/-]: Connection to a DC system

[I1+, I1-, I2+, I2-]: Digital inputs

[A, B, S]: RS-485 interface

[E, KE]: Connection to earth und controlearth

[A1, A2]: Connection to supply voltage

[31, 32, 33] [21, 22, 24] [11, 12, 14]: Connection to the relays K3...K1

Step-by-step connection of the ISOMETER®

Connect the device according to the wiring diagram. Proceed as follows:

1. Connect terminals **E** and **KE** to earth (PE).
2. Connect terminals **A** and **B** to the BMS bus.
3. Connect terminal **S** to the bus conductor shield (only at one end of the conductor).
4. Connect terminals **I1+**, **I1-** and **I2+**, **I2-** with digital control switches.
5. Connect terminal **L1/+** to **L1** of the system to be monitored.
6. Connect terminal **L2/-** to **L2** of the system to be monitored.



*The coupling terminals **L1/+** and **L2/-** are locked. To unplug the terminals, the orange sliders must be slid towards the front (towards the device) to unlock the terminal. Now the terminal can be unplugged.*

7. Connect alarm outputs of the relays **K1**, **K2** und **K3**.
8. Connect terminal **A1/A2** to the supply voltage U_s .

6 Commissioning

6.1 Commissioning diagram

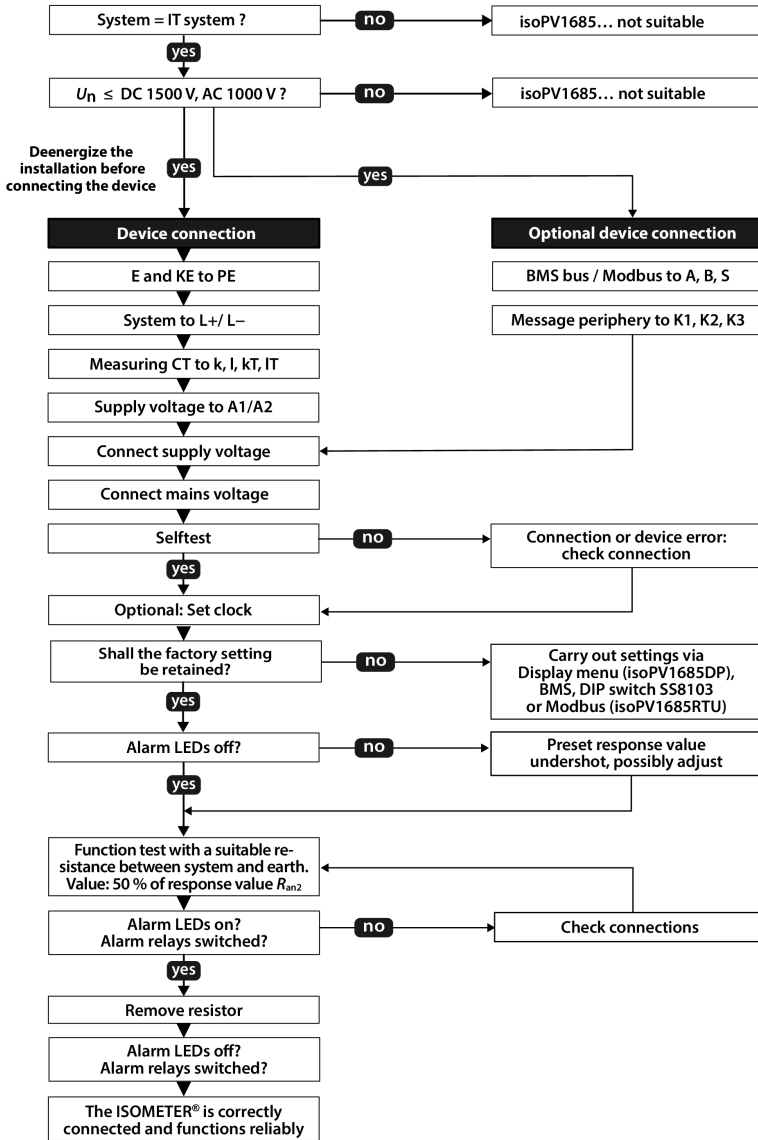

7 Settings

7.1 Set alarm for insulation fault

You can set the limit values for prewarning (Alarm 1) and main alarm (Alarm 2) of the ISOMETER® via a BMS gateway or BMS terminal programme. The activation or deactivation of the two alarm levels R_{an1} and R_{an2} can be seen in the following graphic:

An alarm becomes inactive when it has exceeded the hysteresis of the set trigger value.

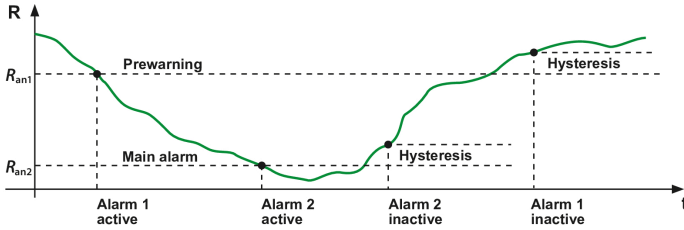

For the prewarning and the main alarm, an insulation resistance of $200\ \Omega \dots 1\ M\Omega$ can be set in each case. Condition: Prewarning \geq main alarm.

7.2 Set measuring speed



ADVICE

These settings may only be changed when the voltage is switched off.

The **switch 6** of the DIP switch SS8103 is used to set the profile considering the maximum system leakage capacitance $C_{e\ max}$.

i When the maximum system leakage capacitance $C_{e\ max}$ is set to $2000\ \mu F$ the upper limit of measuring range for the insulation resistance decreases from $1\ M\Omega$ to $50\ k\Omega$. Therefore, check also the settings of the response value R_{an} .

The measurement speed can be changed using **switch 7**. The measurement speed can be set to **Slow** in case of frequently occurring fault alarms caused by transients in the system. In the mode **Slow**, the measurement time doubles.

DIP switch SS8103

Switch 6 (red arrow):

up [OFF] = $500\ \mu F = C_{e\ max}$

down [ON] = $2000\ \mu F = C_{e\ max}$

Switch 7 (green arrow):

up [OFF] = Fast

down [ON] = Slow

Switch 8:

RESERVED

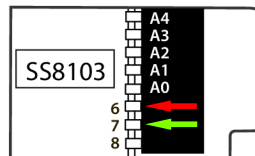

7.3 Parameter setting of the insulation fault location



CAUTION Malfunctions due to excessive locating current

Excessive locating current may cause malfunctions on sensitive system parts like PLC or relay.

Ensure that the level of the locating current is compatible with the system to be monitored.

Set the value of the locating current required for insulation fault location to 1...50 mA.

In order to be able to locate insulation faults, select one of the four available modes for insulation fault location. The selection and configuration is done with a BMS gateway (e.g. COM465IP) or a terminal programme via the BMS bus.

off The insulation fault location is deactivated.

manual In manual mode, the insulation fault location starts immediately. If you start the insulation fault location, it remains active without considering the insulation resistance and the alarm message of the ISOMETER®.

auto In auto mode, the insulation fault location starts when the response value of alarm 2 of the ISOMETER® falls below the preset value. The insulation fault location is cyclically interrupted for an insulation measurement. If the insulation fault is still present after the interruption, the insulation fault location starts again. The insulation fault location only stops if alarm 2 is inactive. If a new insulation fault occurs, the insulation fault location restarts.

1 cycle In 1-cycle mode, the insulation fault location starts when the response value of alarm 2 of the ISOMETER® falls below the preset value. The insulation fault location is stopped after one cycle. If the insulation fault is still present after the interruption, the insulation fault location does NOT start again. If a new insulation fault occurs, the insulation fault location restarts for one cycle.

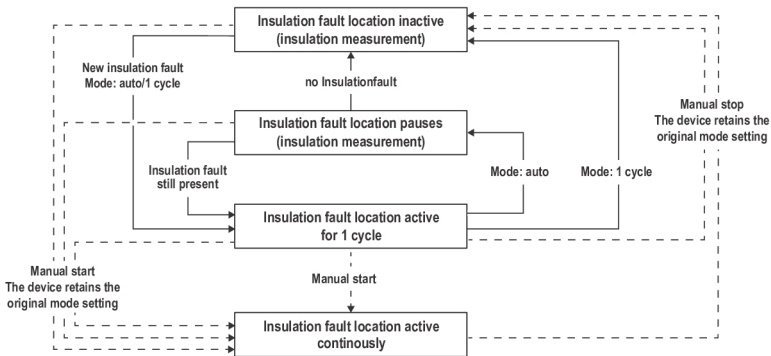

7.4 Deactivate device

When the unit is deactivated, the coupling stage of the unit is galvanically isolated from the mains to be monitored.

The unit is activated or deactivated via BMS channel 10:

- Activating standby mode with the BMS command STDBY 1 (ALARM LED is permanently lit, relays do *not* switch!)
- Deactivate standby mode with the BMS command STDBY 0
- Inquiry of the current state with the BMS command TRSH? 10

For example, the standby operation of an isoPV1685RTU can enable team operation of inverters, as only one insulation monitoring device may be connected in each of the interconnected grids.



ADVICE

Standby mode can also be activated/deactivated via the digital input.

7.5 Resetting alarm messages

Recorded faults are provided as alarm messages on the BMS bus.

Pressing the reset button ST6101 will reset these alarm messages. If the fault persists, the message will be generated again.

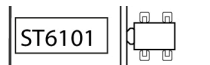

7.6 Parameterisation with the “iso1685 Set” software

The isoPV1685RTU can be parameterised with the **iso1685 Set** software:

- You can download the software at:
<https://www.bender.de/en/service-support/download-area/>



By using the **iso1685 Set** software, you confirm the following conditions:

Bender provides this software free of charge and without warranty. By using the software, you agree to use the software at your own risk. Bender does not assume any warranty for possible software errors or defects and does not guarantee that the software will work error-free and reliably. Furthermore, Bender is not liable for any direct or indirect damage resulting from the use of the software.



The **iso1685 Set** software can only be used if there is no master in the BMS system.

8 Device communication

8.1 RS-485 interface

The RS-485 interface, galvanically isolated from the device electronics, serves as a physical transmission medium for the BMS protocol and the Modbus RTU protocol. When an ISOMETER® or other bus-capable devices are interconnected via the BMS bus in a network, the BMS bus must be terminated at both ends with a 120 Ω resistor. The device isoPV1685RTU is equipped with the terminating switch **RS-485 Term.** (on/off).

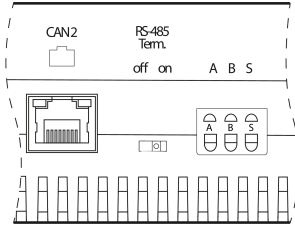

Wiring of a RS-485 network

The optimum topology for an RS-485 network is a daisy-chain connection. In this connection, device 1 is connected to device 2, device 2 to device 3, device 3 to device 4 etc. The RS-485 network represents a continuous path without branches.

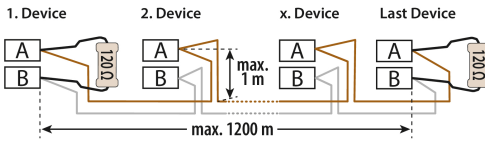

ADVICE

An RS-485 network that is not terminated is likely to become unstable and cause malfunctions. Only the first and last device in one line may be terminated. Hence, stub feeders in the network must not be terminated. The length of the stub feeders is restricted to a maximum of 1 m.

Examples for wrong arrangement

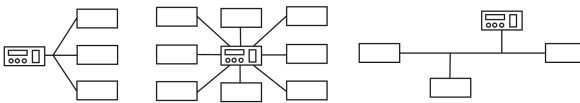

Examples for correct arrangement

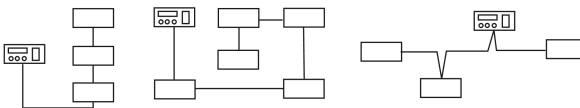

Wiring

The following cable is recommended for wiring the RS-485 network:

Shielded cable, core diameter 0.8 mm (e.g. J-Y(St)Y 2x0.8), shield connected to earth (PE) on one end.

The max number of bus nodes is restricted to 32 devices. If more devices are to be connected, Bender recommends the use of a DI1 repeater.

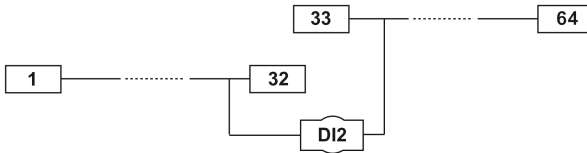

Commissioning of an RS-485 network

- Interconnect terminals **A** and **B** of all bus devices in one line.
- Switch the terminating resistors on at the start and the end of the RS-485 network. If a device at the end of the bus is not terminated, connect a 120 Ω resistor to terminals **A** and **B**.
- Switch the supply voltage on.
- Assign the master function and address 1 to a bus-capable device.
- Assign addresses (2, 3, 4, ... 17) to all other bus devices in consecutive order.

8.2 BMS protocol

BMS protocol

This protocol is an essential part of the Bender measuring device interface (BMS bus protocol). Data transmission generally makes use of ASCII characters.

Interface data are:

- Baud rate: 9600 baud
- Transmission: 1 start bit, 7 data bits, 1 parity bit, 1 stop bit (1, 7, E, 1)
- Parity: even
- Checksum: Sum of all transmitted bytes = 0 (without CR and LF)

The BMS bus protocol works according to the master-slave principle. Only one master may exist in each network. All bus devices are identified by a unique BMS address. The master cyclically scans all other slaves on the bus, waits for their response and then carries out the corresponding commands.

A device receives the master function by assigning bus address 1 to it.

BMS master

A master can query all measured values, alarm and operating messages from a slave. If bus address 1 is assigned to a device, this device automatically operates as master, i.e. all addresses between 1 and 150 are cyclically scanned for alarm and operating messages via the BMS bus. If the master detects incorrect answers from a slave, the fault message **Fault RS-485** is output via the BMS bus.

Possible fault causes:

- Address assigned twice
- Second master on the BMS bus
- Interference signals on the bus lines
- Defective device on the bus
- Terminating resistors not activated or connected



ADVICE

The ISOMETER® isoPV1685RTU cannot be a master and cannot have the address 1.

However, if there is no master in the system, the ISOMETER® becomes a substitute master with a different BMS address (e.g. 2 or 3). The slaves in the system can be addressed via the substitute master.

Commissioning of an RS-485 network with BMS protocol

- Interconnect terminals **A** and **B** of all bus devices in one line.
- Switch the terminating resistors on at the start and the end of the RS-485 network. If a device at the end of the bus is not terminated, connect a 120 Ω resistor to terminals **A** and **B**.
- Switch the supply voltage on.
- Assign the master function and address 1 to a bus-capable device.
- Assign addresses (2...17) to all other bus devices in consecutive order.

8.2.1 Set BMS addresses

i *The ISOMETER® cannot switch on a potential termination at the BMS bus. Even though this is not expected to cause communication problems, the ISOMETER® should be operated as BMS slave if possible (BMS address > 1).*

The BMS address can be changed using DIP switch SS8103. Factory setting = 2

i The A4 switch of the dip switch SS8103 is used to switch between BMS and Modbus.

Switch position	BMS addr.	DIP switch SS8103				
		A4	A3	A2	A1	A0
Up = OFF (0) Down = ON (1)		BMS RTU				
2		0	0	0	0	0
3		0	0	0	0	1
4		0	0	0	1	0
5		0	0	0	1	1
6		0	1	1	0	0
7		0	1	1	0	1
8		0	1	1	1	0
9		0	1	1	1	1
10		1	0	0	0	0
...	
17		1	1	1	1	1

8.2.2 Messages via the BMS bus

Messages are transmitted to a maximum of 12 BMS channels. All alarm, operating and error messages are described below.

Alarm messages

Alarm	Channel	Meaning
Alarm 1 (insulation fault)	1	Insulation resistance Prewarning (Value < response value 1, $R_F < R_{an1}$)
Alarm 2 (insulation fault)	2	Insulation resistance Alarm (Value < response value 2, $R_F < R_{an2}$)
Connection system	4	Connection fault system
Connection PE	5	Connection fault earth
Device error	7	Internal device error
Overtemperature coupling	10	Overtemperature coupling L1/+
Overtemperature coupling	11	Overtemperature coupling L2/-

Operating messages

Alarm	Channel	Meaning
Insulation resistance	1	Current insulation resistance R_F (if $R_F > (R_{an1} + \text{Hysteresis})$)
Insulation resistance	2	Current insulation resistance R_F (if $R_F > (R_{an2} + \text{Hysteresis})$)
Leakage capacitance	4	Leakage capacitance C_e in nF, μF
Mains voltage	5	Current system voltage U_N
Partial voltage U+/PE	6	Current partial voltage terminal L1/+ to earth
Partial voltage U-/PE	7	Current partial voltage terminal L2/- to earth
Temperature coupling	10	Current temperature of the coupling L1/+
Temperature coupling	11	Current temperature of the coupling L2/-

Error codes

Error code	Component	Error	Action
BMS			
0.10	Connection	CT connection	Check connection
0.30	Connection	Connection earth (E/KE)	Check connection
0.40	Connection	Connection system (L1/+ , L2/-)	Check connection
4.05	Parameter	Incorrect measurement method selected	Change measurement method
7.63	System	Timeout system management	Restart the device
8.11	Hardware	Self test insulation measurement	Contact service
8.12	Hardware	Hardware measuring voltage source	Replace the device
8.41	Connection	Mains voltage polarity incorrect (L+ , L-)	Check connection
8.42	Hardware	Supply voltage ADC	Replace the device
8.43	Hardware	Supply voltage +12 V	Replace the device
8.44	Hardware	Supply voltage -12 V	Replace the device
8.45	Hardware	Supply voltage +5 V	Replace the device
8.46	Hardware	Supply voltage +3.3 V	Replace the device
9.61	Parameter	Insulation measurement	Load factory settings and parameterise again
9.62	Parameter	Residual current measurement	Load factory settings and parameterise again

Error code	Component	Error	Action
BMS			
9.64	Parameter	Voltage measurement	Contact service
9.70	System	General software error	Restart the device
9.71	System	Control flow	Restart the device
9.72	System	Programme sequence insulation measurement	Restart the device
9.74	System	Programme sequence voltage measurement	Restart the device
9.75	System	Programme sequence temperature measurement	Restart the device
9.76	System	Programme sequence history memory	Restart the device
9.77	System	Programme sequence console	Restart the device
9.78	System	Programme sequence self test	Restart the device
9.79	System	Stack error	Restart the device
9.80	System	Stack error	Restart the device
9.81	System	Internal programme sequence	Restart the device
9.82	System	Internal programme sequence	Restart the device

Resetting error messages

Recorded errors are presented as alarm messages on the BMS bus.

The fault messages are reset via the device menu. If the fault continues to exist, the message will be generated again. The error can also be reset by means of the acknowledgement command via the BMS bus.

Firmware update via BMS bus

The firmware is updated via the BMS bus with the 'BMS Update Manager', which is available from Bender.

8.3 Modbus RTU protocol

Modbus is an internationally used protocol for data exchange between devices. The Modbus RTU protocol is used by Bender devices for connection in systems with Condition Monitor (e.g. COM465xP) or for connection to third-party systems

The protocol transmits measured values, status messages, control commands or unit parameters in binary form. All measured values, messages and parameters are stored in virtual register addresses. With a read command to a register address, data can be read out. With a write command, data can be written to a register address.

For detailed information about the Modbus RTU protocol, including its properties and commissioning, please refer to the 'Modbus RTU' manual at <https://www.bender.de/en/service-support/download-area/>.

9 Technical data

9.1 Diagrams

System leakage capacitance

The determination of the leakage capacitance depends on the size of the insulation resistance.

Examples

- minimum measurable leakage capacitance at $R_F = 50 \text{ k}\Omega$: **35 μF**
- minimum measurable leakage capacitance at $R_F = 5 \text{ k}\Omega$: **210 μF**

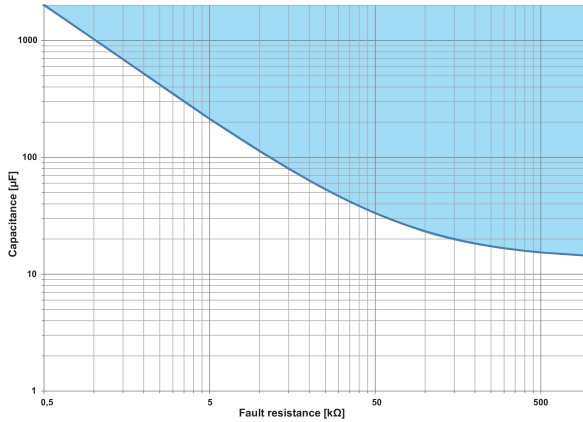

Response time



ADVICE

In the case of a leakage capacitance of 2000 μF , the measuring range for the insulation resistance is limited to 50 k Ω .

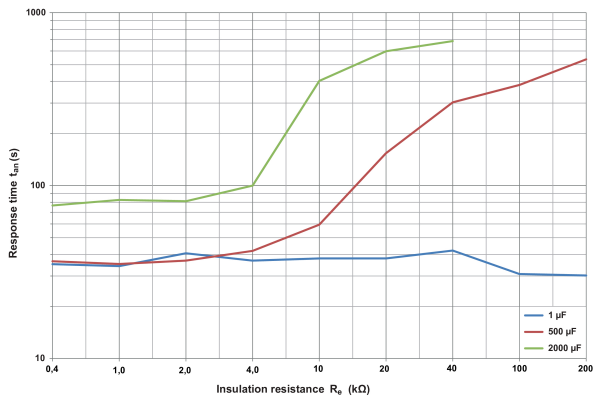

9.2 Factory settings

Parameter	Value	Setting via		
		SS8193	BMS	Modbus RTU
Response value R_{an1} (ALARM 1)	10 k Ω		×	×
Response value R_{an2} (ALARM 2)	1 k Ω		×	×
Fault memory	off		×	×
Relay K1	N/C operation		×	×
Relay K2	N/C operation		×	×
Relay K3	N/C operation			
Reset to factory settings	---		×	×
BMS address	2	×		
BMS termination	ON	×		
System leakage capacitance	$\leq 500 \mu\text{F}$	×		
Measurement speed	Fast	×		
Time	not defined		×	×

9.3 Tabular data isoPV1685RTU

Insulation coordination acc. to IEC 60664-1/IEC 60664-3

Rated voltage	DC 1500 V
Rated impulse voltage	10 kV
Pollution degree	2

Voltage range

Nominal system voltage range U_n	AC 0...1000 V, DC 0...1500 V
Nominal frequency range	50/60 Hz ± 1 Hz
Tolerance of U_n	AC +10 %, DC + 6 %
Supply voltage U_s	DC 18...30 V
Power consumption	≤ 7 W

Measuring circuit for insulation monitoring

Measuring voltage U_m (peak)	± 50 V
Measuring current I_m (at $R_F = 0 \Omega$)	≤ 1.5 mA
Internal DC resistance R_i	≥ 70 k Ω
Impedance Z_i at 50 Hz	≥ 70 k Ω

Permissible extraneous DC voltage U_{fg}	≤ DC 1500 V
Permissible system leakage capacitance C_e	≤ 2000 μ F

Response values for insulation monitoring

Response value R_{an1} (Alarm 1)	200 Ω ... 1 M Ω
Response value R_{an2} (Alarm 2)	200 Ω ... 1 M Ω
Upper limit of the measuring range when set to $C_{e\max} = 2000 \mu$ F	50 k Ω
Relative uncertainty (10 k Ω ... 1 M Ω) (nach IEC 61557-8)	± 15 %
Relative uncertainty (0.2 k Ω ... < 10 k Ω)	± 200 Ω ± 15 %
Response time t_{an}	see Response time
Hysteresis	25 %, +1 k Ω

Display, storage

LEDs for alarms and operating states	2x green, 4 x yellow
μ SD card (Spec. 2.0) for history memory and log files	≤ 32 GB

Inputs

Digital inputs DigIn1 / DigIn2:	
High level	10 ... 30 V
Low level	0 ... 0.5 V

Serial interface

Interface	RS485
Protocol	BMS (Slave) Modbus RTU (Slave); switchable
Connection	Terminals A/B Shield: Terminal S
Cable length	≤ 1200 m
Shielded cable (shield to functional earth on one end)	2-core, ≥ 0.6 mm ² , e.g. J-Y(St)Y 2×0.6
Terminating resistor, can be connected (RS-485 Term.)	120 Ω (0.5 W)
Device address, BMS bus or Modbus adjustable	2 ... 17

Switching elements

Switching elements	3 changeover contacts
K1	Insulation fault alarm 1
K2	Insulation fault alarm 2
K3	Device error
Operating principle K1, K2	N/C operation, N/O operation
Operating principle K3	N/C operation, cannot be changed
Contact data acc. to IEC 60947-5-1:	
Utilisation category	AC 13 AC 14 DC-12 DC-12 DC-12
Rated operational voltage	230 V 230 V 24 V 110 V 220 V
Rated operational current	5 A 3 A 1 A 0.2 A 0.1 A
Minimum contact rating	1 mA bei AC/DC \geq 10 V
<i>For UL applications:</i> Utilisation category for AC control circuits with 50/60 Hz (Pilot duty)	B300
AC load of the alarm relay outputs	AC 240 V, 1.5 A in case of a power factor of 0.35
AC load of the alarm relay outputs	AC 120 V, 3 A in case of a power factor of 0.35
AC load of the alarm relay outputs	AC 250 V, 8 A in case of a power factor of 0.75...0.80
DC load of the alarm relay outputs	DC 30 V, 8 A in case of ohmic load

Connection (except system coupling)

Connection type	pluggable push-wire terminals
Connection, rigid/flexible	0.2...2.5 mm ² / 0.2...2.5 mm ²
Connection, flexible with ferrule, without/with plastic sleeve	0.25...2.5 mm ²
Conductor sizes (AWG)	24...12

Connection of the system coupling

Connection type	pluggable push-wire terminals
Connection, rigid/flexible	0.2...10 mm ² / 0.2...6 mm ²
Connection, flexible with ferrule, without/with plastic sleeve	0.25...6 mm ² / 0.25...4 mm ²
Conductor sizes (AWG)	24...8
Stripping length	15 mm
Opening force	90...120 N

Environment/EMC

EMC	IEC 61326-2-4
Ambient temperature during operation	-40...+70 °C
Ambient temperature transport	-40...+80 °C
Ambient temperature long-term storage	-25...+80 °C
Relative humidity	10...100 %

Classification of climatic conditions acc. to IEC 60721:

Stationary use (IEC 60721-3-3)	3K23
Transport (IEC 60721-3-2)	2K11
Long-term storage (IEC 60721-3-1)	1K22

Classification of mechanical conditions acc. to IEC 60721:

Stationary use (IEC 60721-3-3)	3M11
Transport (IEC 60721-3-2)	2M4
Long-term storage (IEC 60721-3-1)	1M12
Atmospheric pressure	700...1060 hPa (max. height 4000 m)

Other

Operating mode	continuous operation
Position of normal use	vertical, system coupling on top
PCB fixation	lens head screw DIN7985TX
Tightening torque	4.5 Nm
Degree of protection, internal components	IP30
Degree of protection, terminals	IP30
Weight	≤1300 g

9.4 Standards and approvals

The ISOMETER® isoPV1685RTU was developed in compliance with the following standards:

- DIN EN 60664-1 (VDE 0110-1)
- DIN EN 61557-8 (VDE 0413-8)
- IEC 60730-1
- IEC 61326-2-4
- IEC 61557-8
- UL 1998 (Software)
- UL 508



9.5 Ordering details

Model	Response value	Nom. system voltage	Supply voltage	Art. No.
isoPV1685RTU-425	200 Ω...1 MΩ	AC 0...1000 V DC 0...1500 V	DC 24 V ±25%	B91065603

Change log manual isoPV1685RTU

Date	Document version	Software version	Changes
11/2021	07	D0532 V3.0x	Editorial revision NEW: isoPV1685RTU, can be used in AC circuits, Digital inputs P. 9, Table modified P. 28, Diagrams scaled, Alarmsettings new formatted UKCA-Certificate Change log
03/2023	08		Editorial revision Modifications UL
03/2025	D00504/00	isoPV1685RTU: D0532 V3.0x	NEW CI -> 1st SMC-Version, Editorial revision



Bender GmbH & Co. KG

Londorfer Straße 65
35305 Grünberg
Germany

Tel.: +49 6401 807-0
info@bender.de
www.bender.de

Alle Rechte vorbehalten.
Nachdruck und Vervielfältigung nur mit
Genehmigung des Herausgebers.

All rights reserved.
Reprinting and duplicating only with
permission of the publisher.



© Bender GmbH & Co. KG, Germany
Subject to change! The specified
standards take into account the edition
valid until 03.2025 unless otherwise
indicated.