



LINETRAXX® VMD420

Spannungs- und Frequenzrelais

zur Überwachung von 3(N)AC-Systemen mit 0...500 V auf Über- und Unterspannung, Über- und Unterfrequenz, Phasenfolge, Phasenausfall, Asymmetrie

Voltage and frequency monitor

for monitoring of 3(N)AC systems up to 0...500 V for undervoltage, overvoltage, underfrequency, overfrequency, phase sequence, phase failure, asymmetry



VMD420 Spannungs- und Frequenzrelais

i Bestandteil der Gerätedokumentation sind neben dieser Kurzanleitung die „Sicherheitshinweise für Bender-Produkte“ und das dazugehörige Handbuch, herunterladbar unter <https://www.bender.de/service-support/downloadbereich>.

VME420 Voltage and frequency monitor

i Part of the device documentation in addition to this quickstart is the enclosed “Safety instructions for Bender products” and the manual, downloadable at <https://www.bender.de/en/service-support/downloads>.

Lieferumfang:

- VMD420
- Montageclip (1x)
- Quick-Start DE/EN
- Sicherheitshinweise

Scope of delivery:

- VMD420
- Mounting clip (1x)
- Quick Start DE/EN
- Safety instructions

Bestellangaben:

Ordering information:

Typ	Nennspg. U_n */ Nominal voltage U_n *	Versorgungsspg U_s */ Supply voltage U_s *	Art.-Nr. / Art.-No.	Handbuch Nr. / Manual No.
VMD420-D-1 (Federklemmen / push-wire terminals)	3(N)AC 0...500 V/ 288 V 15...460 Hz	AC 16...72 V/ DC 9,6V...94 V DC, 15...460 Hz	B73010005 B73010005(W)	D00137
VMD420-D-1	3(N)AC 0...500 V/ 288 V 15...460 Hz	AC 16...72 V/ DC 9,6V...94 V DC, 15...460 Hz	B93010005 B93010005(W)	D00137
VMD420-D-2 (Federklemmen / push-wire terminals)	3(N)AC 0...500 V/ 288 V 15...460 Hz	AC/DC 70...300 V DC, 15...460 Hz	B73010006	D00137
VMD420-D-2	3(N)AC 0...500 V/ 288 V 15...460 Hzz	AC/DC 70...300 V DC, 15...460 Hz	B93010006	D00137
*Absolutwerte des Spannungsbereichs / * Absolute values of the voltage range				
Montageclip für Schraubmontage (1 Stück je Gerät, Zubehör) Mounting clip for screw mounting (1 piece per device, accessories)			B98060008	

Bestimmungsgemäße Verwendung

Das Spannungsrelais VMD420 überwacht 3(N)AC-Netze im Frequenzbereich 15...460 Hz auf Unter- und Überspannung sowie auf Unter- und Überfrequenz. Die Geräte eignen sich für den Nennspannungsbereich $U_n = 0...500$ V. Das Gerät benötigt eine separate Versorgungsspannung U_s .

Eine andere oder darüber hinausgehende Benutzung gilt als nicht bestimmungsgemäß.

Intended use

The voltage monitor VMD420 monitors 3(N)AC systems in the frequency range 15...460 Hz for undervoltage, overvoltage, underfrequency and overfrequency. The devices are designed for the nominal voltage range $U_n = 0...500$ V. Separate supply voltage U_s is required.

Any use other than that described in this manual is regarded as improper.

Abmessungen

Dimensions

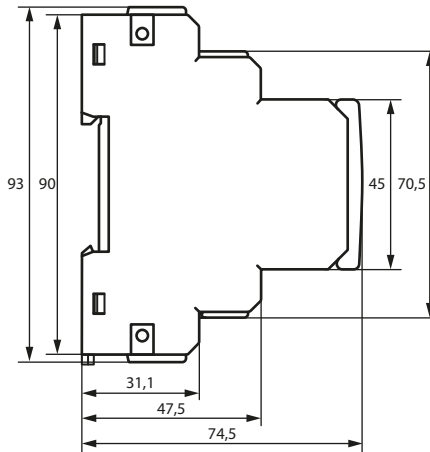
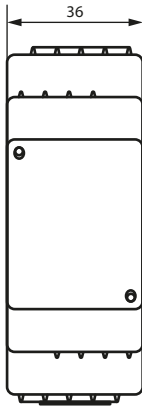

Montage

Mounting

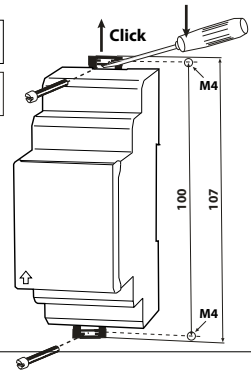
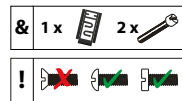
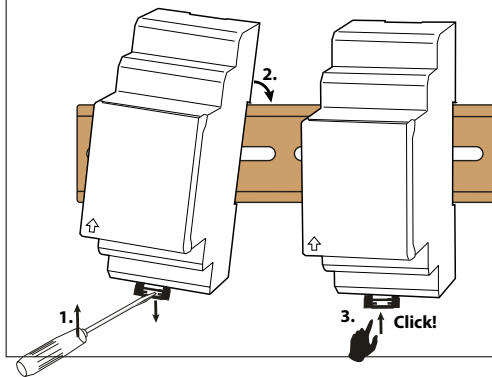

Variante A/Option A:

Montage auf Hutschiene/DIN rail mounting

Variante B/Option B:

Schraubbefestigung/Screw mounting

i Anwendung in Schienenfahrzeugen / DIN EN 45545-2:2016! Beträgt der Abstand zu benachbarten Komponenten, die nicht die Anforderung der Norm DIN EN 45545-2 Tabelle 2 erfüllen, horizontal < 20 mm oder vertikal < 200 mm, sind diese als gruppiert zu betrachten.

i Application in railway vehicles/DIN EN 45545-2:2016! If the horizontal or vertical distance to adjacent components which do not meet the requirements in table 2 of DIN EN 45545-2 is less than 20 mm or less than 200 mm respectively, they are to be regarded as grouped.

Anschluss

Wiring

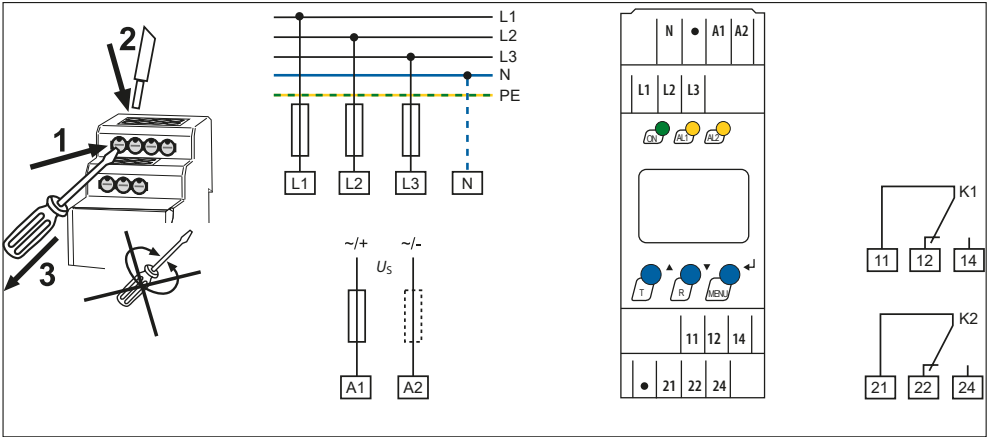

Klemme	Anschlüsse
A1, A2	Anschluss der Versorgungsspannung U_s
L1, L2, L3, (N)	Anschluss an das zu überwachende System
11, 12, 14	Alarm-Relais K1
21, 22, 24	Alarm-Relais K2

Terminal	Connections
A1, A2	Connection of supply voltage U_s
L1, L2, L3, (N)	Connection to the system to be monitored
11, 12, 14	Alarm relay K1
21, 22, 24	Alarm relay K2

Inbetriebnahme

Vor der Inbetriebnahme ist der ordnungsgemäße Anschluss des Spannungsrelais zu überprüfen.

1. Anlegen einer Spannung an den Messspannungseingang (L1, L2, L3, N).
2. Anlegen der Versorgungsspannung an A1 und A2.
3. Nach Anlegen der Messspannung und der Versorgungsspannung führt das VMD420 bei der ersten Inbetriebnahme die Preset-Funktion aus, siehe nachfolgende Beschreibung.

Commissioning

Prior to commissioning, check proper connection of the voltage monitor.

1. Connecting a voltage to the measuring voltage input (L1, L2, L3, N).
2. Connecting the supply voltage to A1 and A2.
3. After connecting the measuring voltage and the supply voltage, the VMD420 performs the preset function at the first start-up, see following description.

Preset-Funktion/Werkseinstellung

Bei erster Inbetriebnahme stellen sich in Abhängigkeit von U_n automatisch vordefinierte Ansprechwerte ein:

Ansprechwert Überspannung (> U)	$1,1 U_n$
Ansprechwert Unterspannung (< U)	$0,85 U_n$
Hysterese U	5 %
Unterfrequenz < Hz	$f_n - 1 \text{ Hz, OFF}$
Überfrequenz > Hz	$f_n + 1 \text{ Hz, OFF}$
Hysterese Frequenz (Hys Hz)	0,2 Hz
Frequenzalarm (< U Hz)	on
Fehlerspeicher (M)	on
Arbeitsweise K1 (> U, Asy)	Arbeitsstrom-Betrieb (n.o.)
Arbeitsweise K2 (< U, Asy)	Ruhestrom-Betrieb (n.c.)
AL1/AL2 signalisieren Alarmzustand von K1/K2 (LEd)	OFF
Alarm bei Gerätestart an K1/K2 (S.AL)	OFF
Anlaufverzögerung (t)	$t = 0 \text{ s}$
Asymmetrie (Asy)	30 %
Phasenfolge-Überwachung	OFF
Ansprechverzögerung	$t_{on1} = 0 \text{ s}$ $t_{on2} = 0 \text{ s}$
Rückfallverzögerung	$t_{off} = 0,5 \text{ s}$
Messmethode	3Ph (Außenleiter-Messung)
Passwort	0, OFF

Für den Fall, dass die gemessene Spannung außerhalb des in der Tabelle definierten Preset-Arbeitsbereichs liegt, erscheint im Display die Meldung „AL not Set“. Somit ist es erforderlich, die Ansprechwerte für Alarm 1 (AL1) und Alarm 2 (AL2) manuell einzustellen. Der Ablauf ist detailliert im Abschnitt „Einstellen der Parameter“ beschrieben.

Die Preset-Funktion wird nach Rücksetzen auf die Werkseinstellungen erneut ausgeführt.

Während des Betriebs können Sie über das Menü S**E**t die Preset-Funktion manuell starten.

Preset function/factory setting

During the first start-up process the following response values are automatically set related to U_n :

Response value overvoltage (> U)	$1.1 U_n$
Response value undervoltage (< U)	$0.85 U_n$
Hysteresis U	5 %
Underfrequency < Hz	$f_n - 1 \text{ Hz, OFF}$
Overfrequency > Hz	$f_n + 1 \text{ Hz, OFF}$
Hysteresis frequency (Hys Hz)	0.2 Hz
Frequency alarm (< U Hz)	on
Fault memory (M)	on
Operating principle K1 (> U, Asy)	N/O operation-(n.o.)
Operating principle K2 (< U, Asy)	N/C operation (n.c.)
AL1/AL2 indicate the alarm state of K1/K2 (LEd)	OFF
Alarm to K1/K2 (S.AL) when the device is started	OFF
Start-up delay	$t = 0 \text{ s}$
Asymmetry (Asy)	30 %
Phase sequence monitoring	OFF
Response delay	$t_{on1} = 0 \text{ s}$ $t_{on2} = 0 \text{ s}$
Delay on release	$t_{off} = 0.5 \text{ s}$
Method of measurement	3Ph (phase-to-phase voltage measurement)
Password	0, OFF

If the measured voltage is not within the preset operating range listed in the table, the message "AL not Set" appears on the display. Therefore it is necessary to set the response values for Alarm 1 (AL1) and Alarm 2 (AL2) manually.









A detailed description of the process is given in the chapter "parameter setting".

After restoring the factory settings, the preset function is automatically active again.

During operation, the preset function can be started manually via the menu S**E**t.

Eigene Einstellungen (Übersicht)

User settings (overview)

Menu	Parameter	FAC ¹		Eigene Einstellungen/ User setting	Einstellbereich/ Setting range	AL-LED		
AL	< U	ON	PRESET		V	6 V	2*	
	> U	ON	PRESET		V	500 V	1*	
	U Hys		5 %		%	1 %... 40 %		
	Asy				%	5 %... 30 %	1+2*	
	< Hz	OFF	PRESET		Hz	10 Hz	1+2*	
	> Hz	OFF	PRESET		Hz	500 Hz	1+2*	
	Hz Hys		0.2 Hz		Hz	0,1 Hz... 2,0 Hz		
	< U_Hz	ON				ON / OFF		
	PHS	OFF	R			R / L	1+2*	
out	M	ON				ON / OFF / CON		
	 1	n.o.						
	 2	n.c.						
	 LEd	OFF					1/2 **	
	r1	 1 Err	OFF					
		r1 < U	OFF					
		r1 > U	ON					
		r1 Asy	ON					
		r1 Hz<	ON					
		r1 Hz>	ON					
		 1 PHS	ON					
		 1 S.AL	OFF					***
	r2	 2 Err	OFF					
		r2 U<	ON					
		r2 U>	OFF					
		r2 Asy	ON					
		r2 Hz<	ON					
		r2 Hz>	ON					
		 2 PHS	ON					
 2 S.AL		OFF					***	

Menu	Parameter	FAC ¹		Eigene Einstellungen/ User setting	Einstellbereich/ Setting range	AL-LED
t	$t_{on 1}$	0 s		s	0 s . . . 300 s	
	$t_{on 2}$			s		
	t			s		
	t_{off}	0.5 s	s	0 s . . . 300 s		
Set	L1, L2, L3	3Ph			3Ph/3 n	
		OFF	0			
	FAC					
	PrE	3Ph			3Ph/3 n	
	SYS					
InF						
HiS					Clr	

¹Werkseinstellungen/factory settings

* nur bei LED = off, ** nur bei LED = on, *** je nach Einstellung LED

* only when LED = off, ** only when LED = on, *** depending on LED setting

Technische Daten

Tabellarische Daten

Isolationskoordination nach IEC 60664-1/IEC 60664-3

Bemessungsspannung 400 V

Bemessungs-Stoßspannung/Verschmutzungsgrad 4 kV / III

Sichere Trennung (verstärkte Isolierung) zwischen:

.....(A1, A2) - (N, L1, L2, L3) - (11-12-14) - (21-22-24)

Spannungsprüfung nach IEC 61010-1:

(N, L1, L2, L3) - (A1, A2), (11, 12, 14) 3,32 kV

(N, L1, L2, L3) - (21, 22, 24) 2,21 kV

(A1, A2) - (11, 12, 14) - (21, 22, 24) 2,21 kV

Versorgungsspannung

VMD420-D-1:

Versorgungsspannung U_s AC 16 . . . 72 V / DC 9,6 . . . 94 V

Frequenzbereich U_s 15 . . . 460 Hz

VMD420-D-2:

Versorgungsspannung U_s AC/DC 70 . . . 300 V

Frequenzbereich U_s 15 . . . 460 Hz

Eigenverbrauch ≤ 4 VA

Messkreis

Messbereich (Effektivwert) (L-N) AC / DC 0 . . . 288 V

Messbereich (Effektivwert) (L-L) AC / DC 0 . . . 500 V

Bemessungsfrequenz f_n DC, 15 . . . 460 Hz

Frequenzanzeige 10 . . . 500 Hz

Technical data

Data in tabular form

Insulation coordination acc. to IEC 60664-1/IEC 60664-3

Rated insulation voltage 400 V

Rated impulse voltage/Pollution degree. 4 kV / III

Protective separation (reinforced insulation) between:

.....(A1, A2) - (N, L1, L2, L3) - (11-12-14) - (21-22-24)

Voltage test acc. to IEC 61010-1:

(N, L1, L2, L3) - (A1, A2), (11, 12, 14) 3.32 kV

(N, L1, L2, L3) - (21, 22, 24) 2.21 kV

(A1, A2) - (11, 12, 14) - (21, 22, 24) 2.21 kV

Supply voltage

VME420-D-1:

Supply voltage U_s AC 16 . . . 72 V / DC 9.6 . . . 94 V

Frequency range U_s 15 . . . 460 Hz

VME420-D-2:

Supply voltage U_s AC/DC 70 . . . 300 V

Frequency range U_s 15 . . . 460 Hz

Power consumption ≤ 4 VA

Measuring circuit

Measuring range (r.m.s.) (L-N) AC / DC 0 . . . 288 V

Measuring range (r.m.s.) (L-L) AC / DC 0 . . . 500 V

Rated frequency f_n DC, 15 . . . 460 Hz

Frequency range 10 . . . 500 Hz

Schaltglieder

Anzahl	2 x 1 Wechsler (K1, K2)
Arbeitsweise	Ruhestrom n.c./Arbeitsstrom n.o.
K2: Err, < U, > U, Asy, < Hz, > Hz, PHS, S.AL (Unterspannung < U, Asymmetrie Asy, Ruhestrom n.c.)*	
K1: Err, < U, > U, Asy, < Hz, > Hz, PHS, S.AL (Überspannung >U, Asymmetrie Asy, Arbeitsstrom n.o.)*	
Elektrische Lebensdauer bei Bemessungsbedingungen	10000 Schaltspiele
Kontaktaten nach IEC 60947-5-1:	
Gebrauchskategorie	
.....AC 13..... AC 14 DC-12 DC-12..... DC-12	
Bemessungsbetriebsspannung	
.....230 V..... 230 V 24 V 110 V..... 220 V	
Bemessungsbetriebsstrom	
..... 5 A..... 3 A 1 A 0,2 A..... 0,1 A	
Minimale Kontaktbelastung (Referenzangabe des Herstellers) ...	
..... 1 mA bei AC/DC ≥ 10 V	

(*) = Werkseinstellung

Normen

Das VMD420 entspricht den Anforderungen der Norm DIN EN 45545-2.

Switching elements

Number of changeover contacts	2 x 1 (K1, K2)
Operating principle	N/C operation/N/O operation
K2: Err, < U, > U, Asy, < Hz, > Hz, PHS, S.AL (undervoltage < U, asymmetry Asy, N/C operation n.c.)*	
K1: Err, < U, > U, Asy, < Hz, > Hz, PHS, S.AL (overvoltage >U, asymmetry Asy, N/O operation no.)*	
Electrical endurance.....	10000 switching operations
Contact data acc. to IEC 60947-5-1:	
Utilisation category	
..... AC 13..... AC 14 DC-12 DC-12..... DC-12	
Rated operational voltage	
.....230 V..... 230 V 24 V 110 V..... 220 V	
Rated operational current.....	
..... 5 A..... 3 A 1 A 0.2 A..... 0.1 A	
Minimum contact load (relay manufacturer's reference)	
..... 1 mA at AC/DC ≥ 10 V	

(*) = factory setting

Standards

The VMD420 complies with the requirements of DIN EN 45545-2.



Alle Rechte vorbehalten.
Nachdruck und Vervielfältigung
nur mit Genehmigung des Herausgebers.

All rights reserved.
Reprinting and duplicating
only with permission of the publisher.

Bender GmbH & Co. KG

Postfach 1161 • 35301 Grünberg • Deutschland
Londorfer Str. 65 • 35305 Grünberg • Deutschland
Tel.: +49 6401 807-0 • Fax: +49 6401 807-259
E-Mail: info@bender.de • www.bender.de

Bender GmbH & Co. KG

PO Box 1161 • 35301 Grünberg • Germany
Londorfer Str. 65 • 35305 Grünberg • Germany
Tel.: +49 6401 807-0 • Fax: +49 6401 807-259
E-Mail: info@bender.de • www.bender.de