

**Electrical safety costs little ...**

**... a human life is priceless**





# Electrical safety in hospitals is vital

The benefits offered by modern medical knowledge and technical equipment are overruled by unexpected loss of electrical power.

In certain medical rooms like ICU, OT, time is of the essence and the absolute reliability of electrical systems is of vital importance.

## Safe and secure electrical power systems

Bender systems have provided the answer for reliable and cost effective electrical safety solutions for healthcare facilities for over 70 years. Hospitals around the world rely on Bender products and the technical support of Bender engineers, where the safety of patients and the critical performance of their medical electrical equipment is at stake.

## Bender – Electrical safety in hospitals

### Bender – Your partner in the application of the new international standard for electrical safety in hospitals

Bender is acknowledged as the expert in the design and installation of power systems according to the international standard IEC 60364-7-710: 2002-11: Electrical installations of buildings – Requirements for special installations or locations – medical locations. Bender systems are specially developed for electrical safety management in health care facilities. They provide early detection of critical errors or insulation deteriorations in electrical systems and of medical electrical equipment.

### Principles for an electrical safety management in healthcare facilities

- Insulation faults must not lead to a power failure.
- Fault currents in an electrical system must be reduced to an uncritical level.
- Permanent monitoring of the power supply for medical locations must be guaranteed.
- Fault repairs must be able to be planned in advance to suit patient needs and maintenance purposes.
- The provision of clear unambiguous labelling of power outlets and distribution switchboards with readily available system documentation.

### Optimal electrical safety

Whoever takes responsibility for the building or running of a hospital or any other healthcare facility has to ensure a maximum of electrical safety.

Bender is a reliable partner worldwide developing the appropriate system solution in accordance with the international standard IEC 60364- 7-710: 2002-11 HD 60364-7-710.

As there can be no compromise concerning the safety of patients and staff, we create flexible solutions for your needs. Let us be your partner and take advantage from our expert knowledge

#### ...in the design stage

- Professional advice
- Design support
- Drafting of invitation to tender

#### ...during the installation

- Installation of devices and systems
- Functional test and commissioning
- Fault location/fault clearance
- Adaptation/optimisation
- Operator training

#### ...and later on

- Support
- Inspection/maintenance
- Repair/spares
- Retro-fitting, modifications, extensions

# Content

## **Bender – Electrical safety in hospitals**

■ Safe and secure electrical power systems .....	3
■ Bender: your partner in the application of the new international Standard for electrical safety in hospitals .....	3
■ Optimal electrical safety .....	3
■ Five most important topics concerning electrical safety in healthcare facilities as follows .....	3
<b>A. Which power supply system ensures maximum safety ?</b>	
■ Safety standards in medical locations .....	6
■ The highest demands are made in Group 2 medical locations .....	6
■ The IT system in medical locations .....	7
■ The IT system transformer .....	8
■ The insulation monitoring device .....	8
<b>B. How do you avoid dangerous overloads ?</b>	
■ Load and temperature monitoring .....	9
<b>C. How do you inform your staff ?</b>	
■ Remote alarm indicator and test combination MK series .....	10
<b>D. How do you avoid dangers in case of public electricity supply failure ?</b>	
■ Three supply options for IT systems .....	11 – 12
<b>E. What else can you do for increased safety ?</b>	
■ Insulation fault location in IT systems with the EDS461 system, for intensive care units and operating theatres .....	13
■ TN-S systems: advance information with RCM and RCMS .....	14

<b>The complete solutions</b> .....	16
<b>ISOMETER® IR427 + MK7</b> Insulation-, load- and temperature monitoring device .....	18
<b>ISOMETER® isoMED427P</b> Insulation-, load- and temperature monitoring device .....	20
<b>ISOMETER® IR426-D47</b> Insulation monitoring device for operating theatre lamps .....	22
<b>MK2007</b> Remote alarm indicator and test combination .....	24
<b>MK2430</b> Remote alarm indicator and test combination .....	26
<b>LINETRAXX® CMS460-D4-2</b> Three phase loads monitoring .....	28
<b>Alarm and control panels</b> .....	30
<b>ATICS®</b> Transfer switching and monitoring devices .....	32
<b>IT System Distribution Boards</b> for Operating Theatre and Intensive Care .....	34
<b>EDS151</b> Insulation fault location system .....	35
<b>EDS461</b> Insulation fault location system .....	36
<b>Power supply units</b> .....	37
<b>ES710</b> Single-phase isolating transformer .....	40
<b>DS0107</b> Three-phase isolating transformer .....	41
<b>LINETRAXX® Power Quality and Energy Measurement</b> For transparency in electrical installations .....	42
<b>Bender communication solutions</b> .....	44
<b>References</b> .....	46

**We want to inform you about the five most important topics concerning electrical safety in healthcare facilities as follows:**

- A** Which power supply system ensures maximum safety?
- B** How do you avoid dangerous overloads?
- C** How do you inform your staff?
- D** How do you avoid dangers in case of public electricity supply failure?
- E** What else can you do for increased safety?

# A Which power supply system ensures maximum safety?

## Safety standards in medical locations

According to IEC 60364-7-710: 2002-11, the medical procedures carried out in a room, define the group classifications of medical locations.

### 710.3.5 Group 0

- Medical locations where no applied parts are intended to be used.

### 710.3.6 Group 1

Medical locations where applied parts are intended to be used, as follows:

- Externally
- Invasively to any part of the body, but not to the heart, except where 710.3.7 applies.

### 710.3.7 Group 2

Medical locations where applied parts are intended to be used in applications such as intracardiac procedures, operating theatres and vital treatment where failure of the supply can cause danger to life.

## The highest demands are made in Group 2 medical locations

A first fault must not result in power supply interruption and hence to failure of life-support equipment. IEC 60364-7-710: 2002-11 requires the IT system (unearthed system) for all Group 2 medical locations

### 710.413.1.5

In Group 2 medical locations, the medical IT system shall be used for:

- Circuits supplying medical electrical equipment and systems intended for life-support or surgical applications
- Other technical equipment in the patient environment

## The following rooms are of special concern:

- Anaesthetic rooms
- Operating theatres
- Operating preparation rooms
- Operating recovery rooms
- Heart catheterization rooms
- Intensive care rooms
- Angiographic examination rooms
- Premature baby rooms



# A IT systems (unearthed systems) – for a reliable power supply

## The IT system in medical locations

The use of an IT system is the backbone of a reliable power supply in medical locations. Contrary to an earthed system (TN system) there is no conductive connection between active conductors and the protective earthing conductor within the IT system.

### Thus four essential demands are met:

- When a first insulation fault occurs the power supply is not interrupted by the tripping of a protective device.
- Medical electrical equipment continues to function.
- Fault currents are reduced to an uncritical level for patient and medical staff.
- No panic breaks out in the operating theatre because power failure is averted.
- Many national and international standards regard the use of the IT system as the backbone of a safe power supply in medical locations, for example:

## Special brochure for: NEC/NFPA/UL/CSA/JES/AS

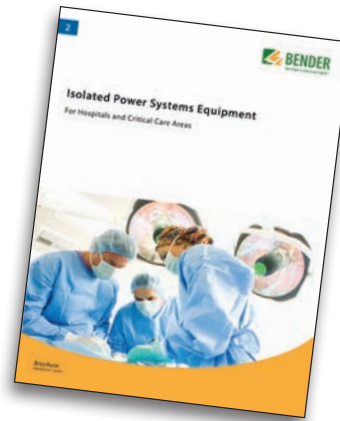

<http://bender-us.com/solutions/healthcare.aspx>

International:	IEC 60364-7-710	Spain:	UNE 20460-7-710	Russia:	GOST P 50571
Germany:	DIN VDE 0100-710	Belgium:	T 013	China:	GB16895/GB50333-2002
Austria:	ÖVE/ÖNORM E 8007	Finland:	SFS 6000	Indonesia:	SNI 0225:2011/BAB 8.27
France:	NFC 15-211	Hungary:	MSZ 2040	Malaysia:	MS IEC 60364-7-710:2009 / MS 2366:2010
Italy:	CEI 64-4	Ireland:	ETCI 10.1	South Korea:	KS C IEC 60364-7-710 / Electrotechnical Regulation Article 249
Brazil:	NBR 13543	Netherlands :	NEN 3134	Thailand:	TIS 2433-2555/พฉร. 2433-2555
UK:	BS 7671 GN7/HTM06-01	Slovakia:	STN 33 2140	Vietnam:	TCVN 7447-7-710
Norway:	64/747/FDIS	South-Africa:	SABS 051		

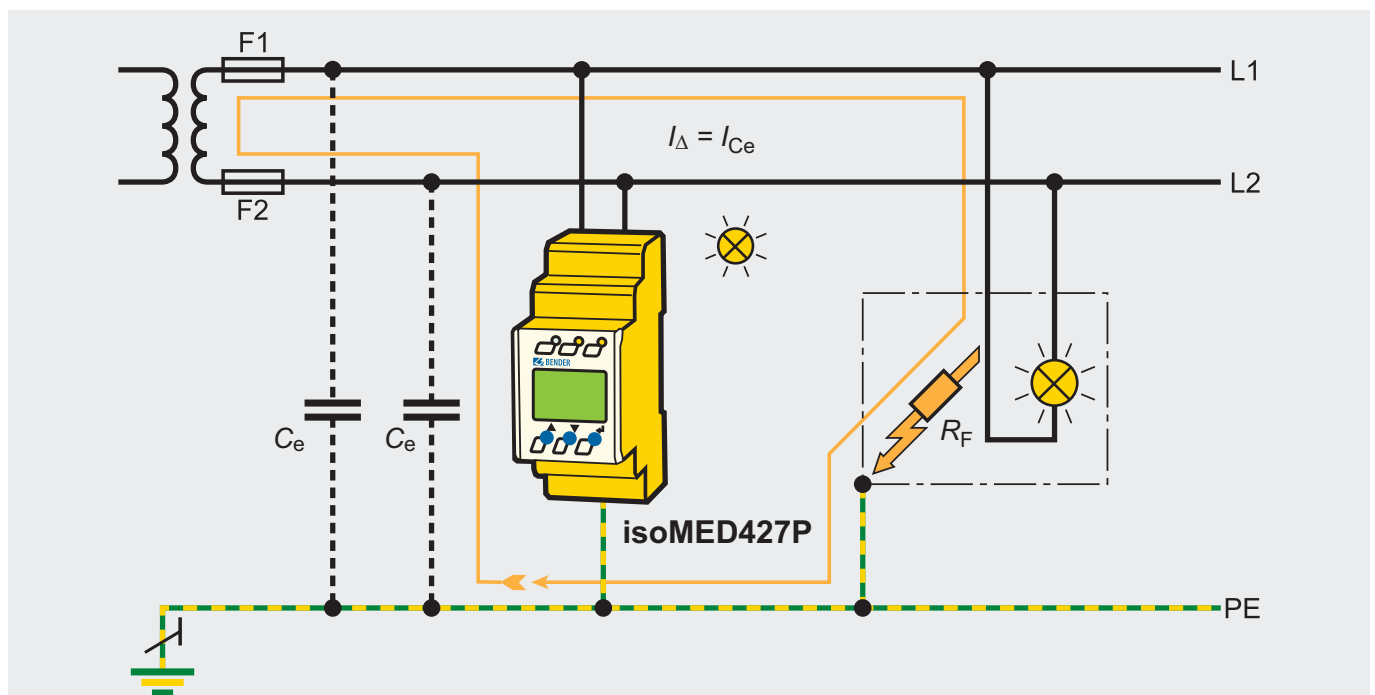

IT system with insulation monitoring by ISOMETER® isoMED427P

# A

## Insulation monitoring – safety plus thanks to advance information

The medical IT system consists of an isolating transformer, a monitoring device to monitor the insulation resistance, transformer load and temperature and a remote alarm indicator and test combination, installed in the operating theatre or at a manned nurse station nearby. Continuous insulation monitoring (IEC 60364-7-710: 2002-11, section 413.1.5) ensures that a deterioration in insulation resistance is immediately detected and signalled but (this is the decisive factor) there is no power supply interruption and continuity of operation is guaranteed.

### The IT system transformer

In accordance with IEC 60364-7-710: 2002-11, section 512.1.6, the rated output of the transformer shall not be less than 0.5 kVA and shall not exceed 10 kVA. Single-phase transformers shall be used. The secondary voltage shall not exceed AC 250 V, even if three-phase systems are fitted. Three-phase systems are allowed for three-phase loads only.

### The insulation monitoring device

The insulation monitoring device isoMED427P is a vital unit to ensure the availability of the IT system. Connected between system and earth, it continuously monitors the insulation resistance. The integrated AMP measuring principle allows insulation faults even with DC components to be precisely recorded and indicated.

Simultaneously, the ISOMETER® isoMED427P monitors the load current and the temperature of the transformer. Additionally it meets the requirements of IEC 60364-7-710: 2002-11, section 413.1.5 and IEC 61557-8, AnnexA: 2007-01.

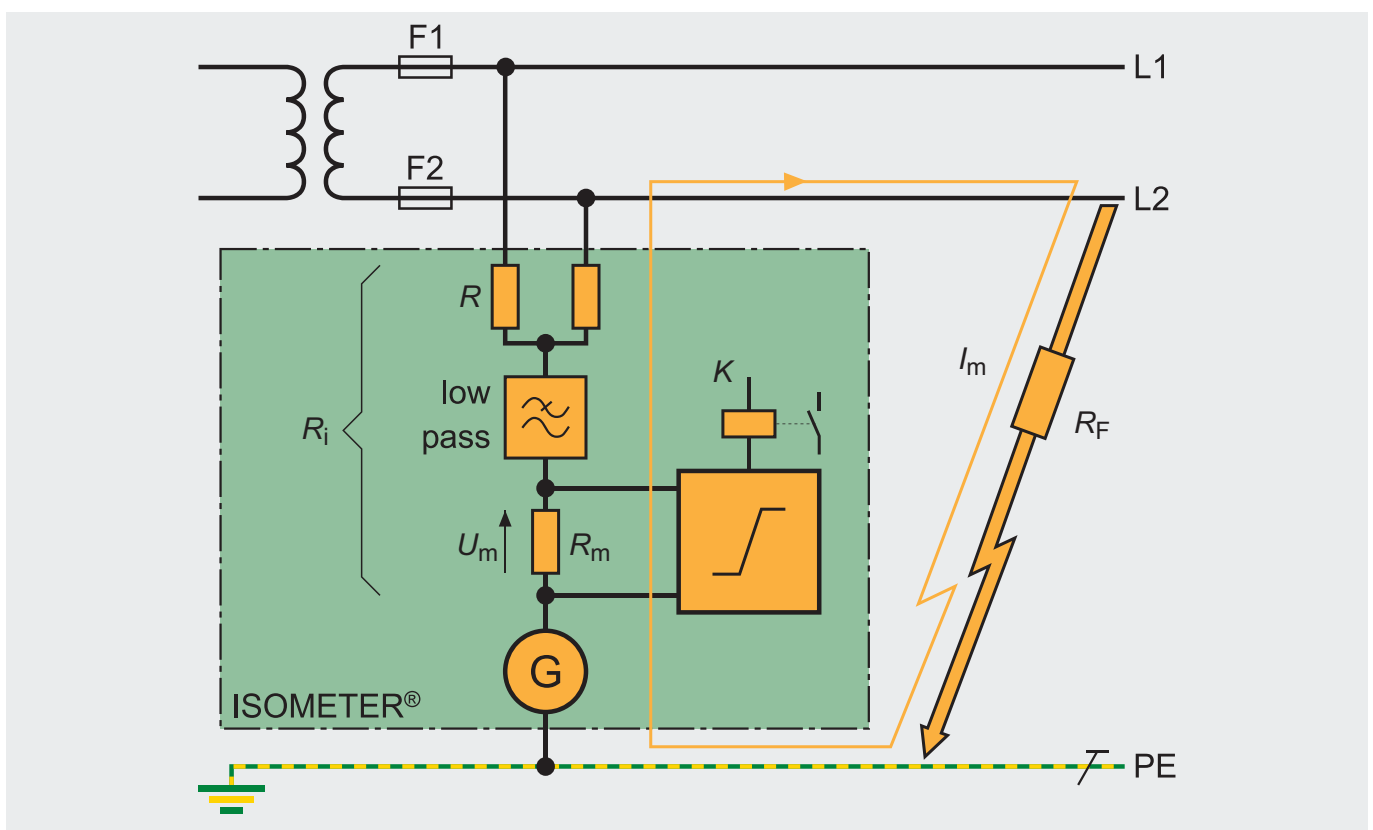

Function principle of insulation monitoring



# B How do you avoid dangerous overloads?

## Load and temperature monitoring

The load an IT system transformer can put at the user's disposal is not endless. Therefore monitoring of overload and transformer temperature according to IEC 60364-7-710 2002-11, section 413.1.5 is required.

- Measurement and indication of excessive heating of the transformer sensed by PTC resistors. [ $>^{\circ}\text{C}$ ]
- Measuring and recording of the load current sensed via measuring current transformers. [ $>\text{A}$ ]
- Thus, an overload of the system can effectively be signalled and the staff is informed by an optical and acoustical signal, so that the load can be reduced by switching off unnecessary equipment.

In the main feeder of the IT system transformer, overcurrent protective devices are only used for protection against short-circuits, so that an overload does not lead to a power failure. Consequently the running of the medical technical equipment is not at any risk.

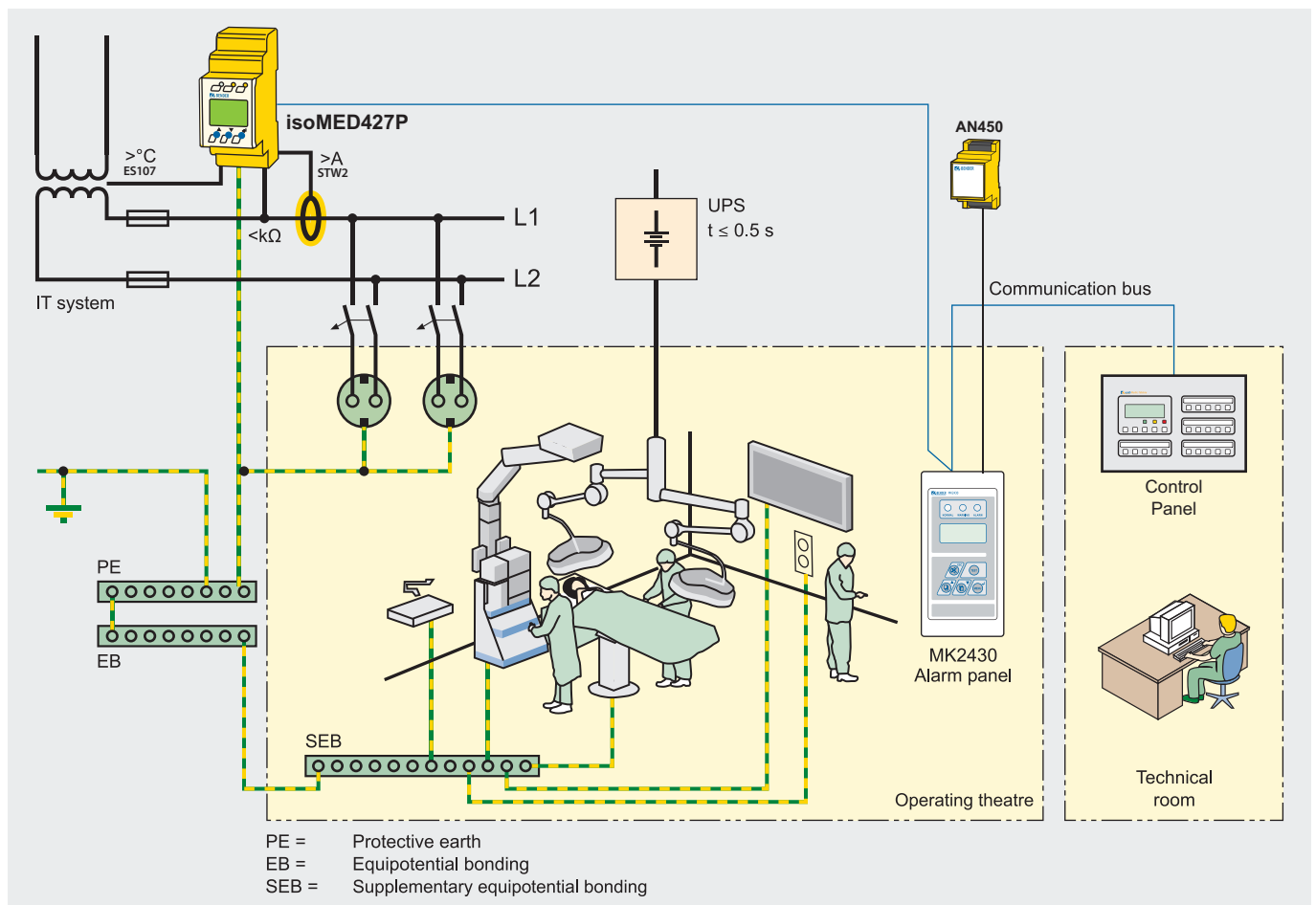

IT system with load and temperature monitoring



# How do you inform your staff?

Continuous information about the status of the electrical installation is vital where reliability of supply is of paramount importance.

### Remote alarm indicator and test combination MK series

The remote alarm indicator and test combinations of the MK series meet the requirements of IEC 60364-7-710: 2002-11, section 413.1.5, for modern information and communication systems in hospitals in various ways. Installed in medical locations, the MK series provides audible and visual signals, to immediately inform the staff.

The MK2430 contains a seven-segment-display to indicate the insulation resistance and the load current as well as various alarm LEDs and buttons for "Isometer testing" and "buzzer off".

The LC text display of MK2430 only shows the important information required in a given situation, in this way confusion caused by a flood of information is prevented. As users have the choice of 16 national languages, the MK2430 is perfectly designed for international use.

The MK2430 version allows programming of individual alarm text messages, for eight additional digital inputs from other electrical equipment (e. g. monitoring of medical gases) via the bus.

### Cost-saving installation

The exchange of information between the ISOMETER® isoMED427P and the MK series takes place via a time and cost-saving installation of a two-wire bus. This facilitates the installation of simple parallel indications and information networks.

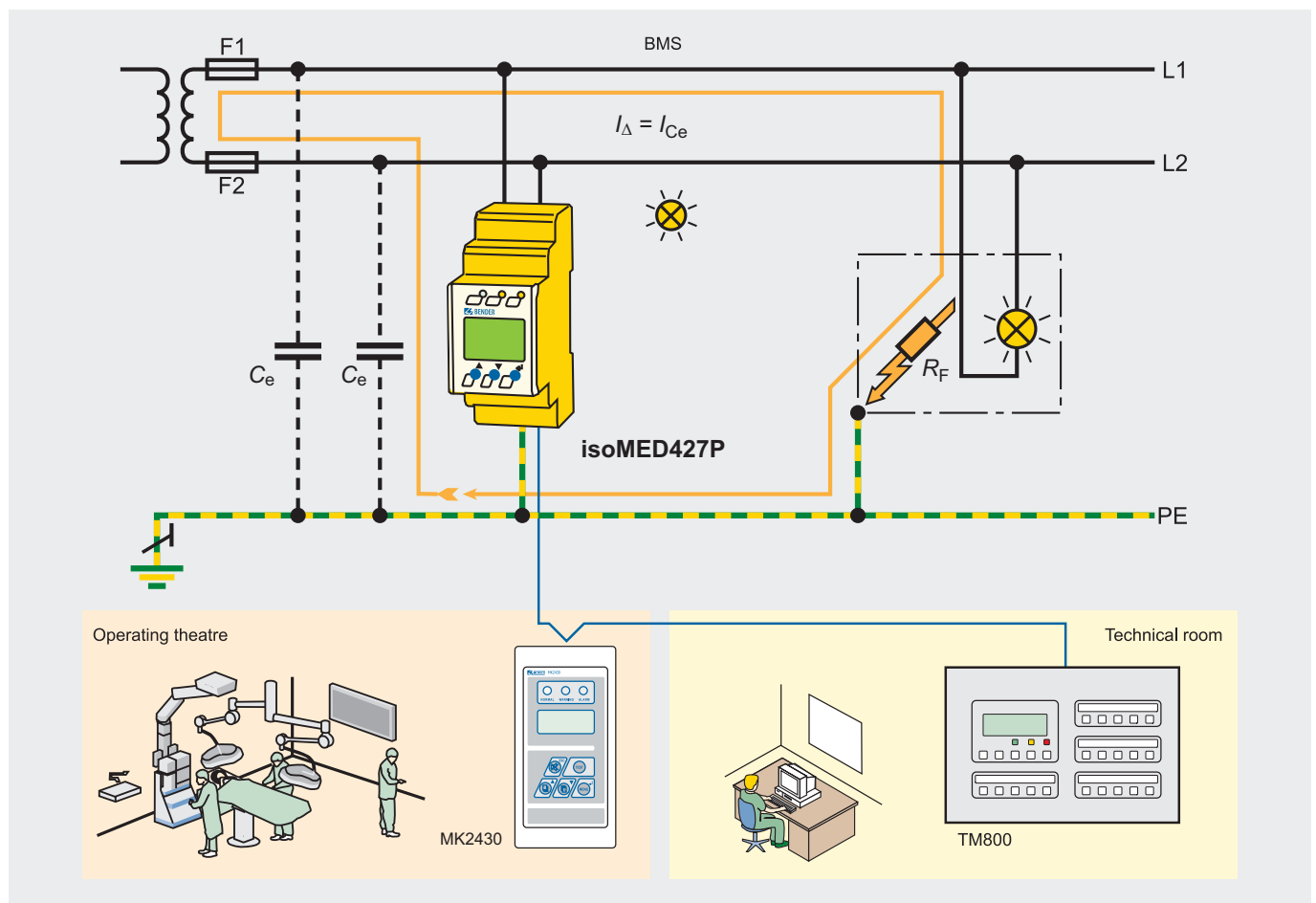

Staff information with MK2430



# How do you avoid dangers in case of public electricity supply failure?

Due to the vital importance of electrical safety in hospitals, healthcare facilities mostly have at least two independent sources of power supply at their disposal (e. g. public electricity supply, generators, UPS). In this way, power failures of the public electricity supply do not lead to a failure of medical electrical equipment that exposes patients to danger.

According to IEC 60364-7-710: 2002-11, section 313, in medical locations, the distribution system should be designed and installed to facilitate the automatic changeover from the main distribution system to the electrical safety power source feeding essential loads. This automatic changeover device requires a „safe separation“ between systems as defined in IEC 60364-5-536.2.2.4, which does not allow semiconductor devices to be used as isolating devices.

IEC 60364-7-710, section 556.5.2.1.1: In medical locations, a power supply for safety services is required, which, in case of a failure of the normal power supply source, shall be energised to feed the equipment with electrical energy for a defined period of time and within a predetermined changeover period.

Depending on their medical tasks, Group 1 and Group 2 medical locations have different needs concerning the permitted changeover period and the tolerable duration of a power interruption.

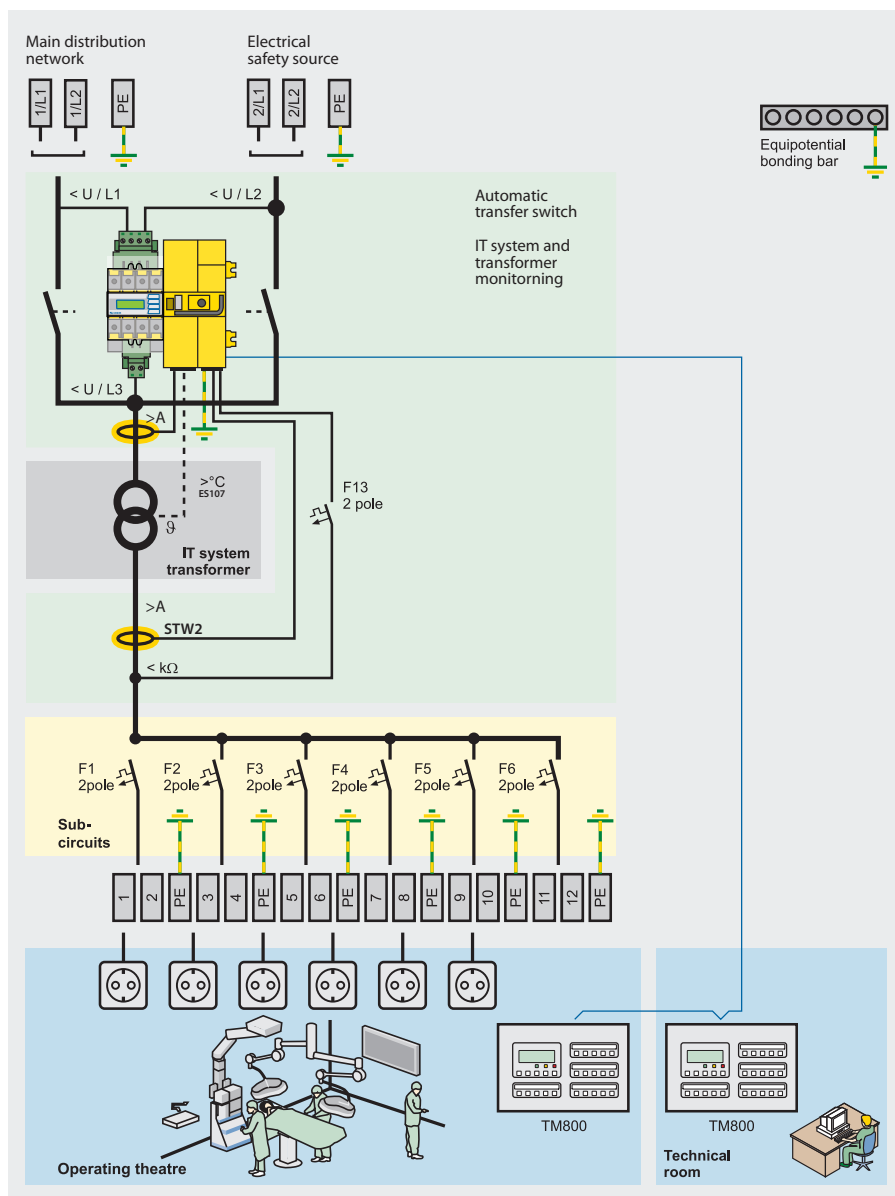

### Power supply sources with ... a changeover period < 0.5 s

- Luminaires of operating theatre tables and other essential luminaires for a minimum period of 3 hours.

### ... a changeover period < 15 s

- Safety lighting
- Medical electrical equipment in Group 2 medical locations
- Equipment of medical gas supply
- Fire detection

### ... a changeover period > 15 s

- Equipment essential for maintaining hospital services (e. g. cooling equipment, cooking equipment, sterilisation equipment)

Power supply for Group 2 medical locations

## Three supply options for IT systems:

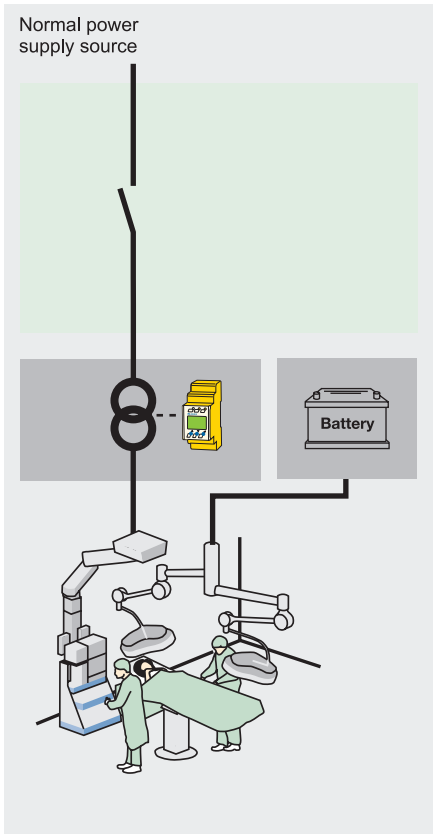

IT system with one supply cables

### 1. One supply cable

The IT system is supplied by only one supply cable. If the supply cable is interrupted, a complete power failure is tolerated. (This system is not permitted in Germany and Austria).

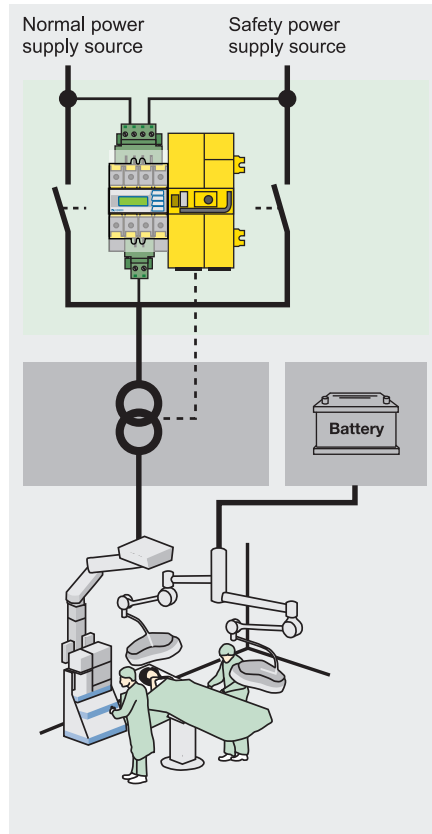

IT system with two supply cables

### 2. Two supply cables

The IT system is supplied by two supply cables. In the event the first cable fails, automatic transfer to the second cable, takes place.

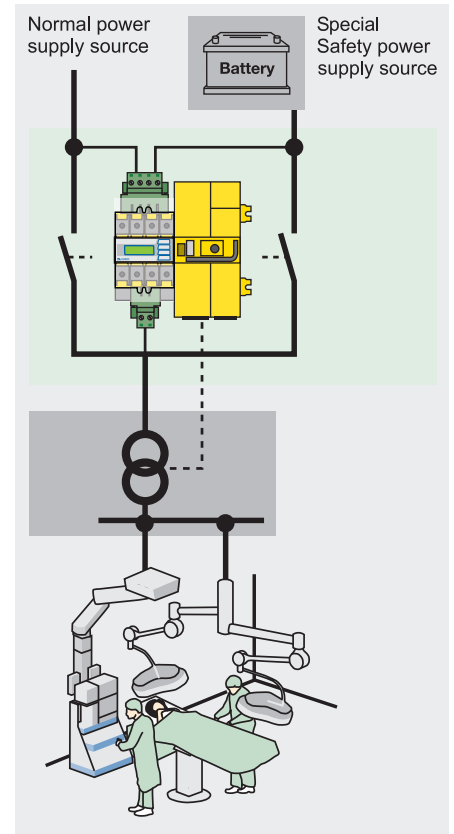

IT system with two supply cables and a special safety power supply source

### 3. Two supply cables but with a safety power source

The second cable derives the power from a special safety power supply source. That ensures the supply of life-support equipment, independently from the external and internal power supply.

#### In case, the ATICS® transfer switching device is installed, the following tasks are carried out:

- Voltage monitoring of the preferred and second supply.
- Transfer to the second supply if the voltage at one or several line conductors drops by more than 10 % of the nominal voltage.
- Monitoring of the switching elements.
- Safe separation between supply lines
- Automatic return to the preferred supply on recovery of its voltage.
- Insulation, load and temperature monitoring of the IT system.

Additionally, the technical staff has optical and acoustical status information of the medical IT system by MK... remote alarm indicators and test combinations.



# What else can you do for increased safety? Insulation fault location for critical rooms

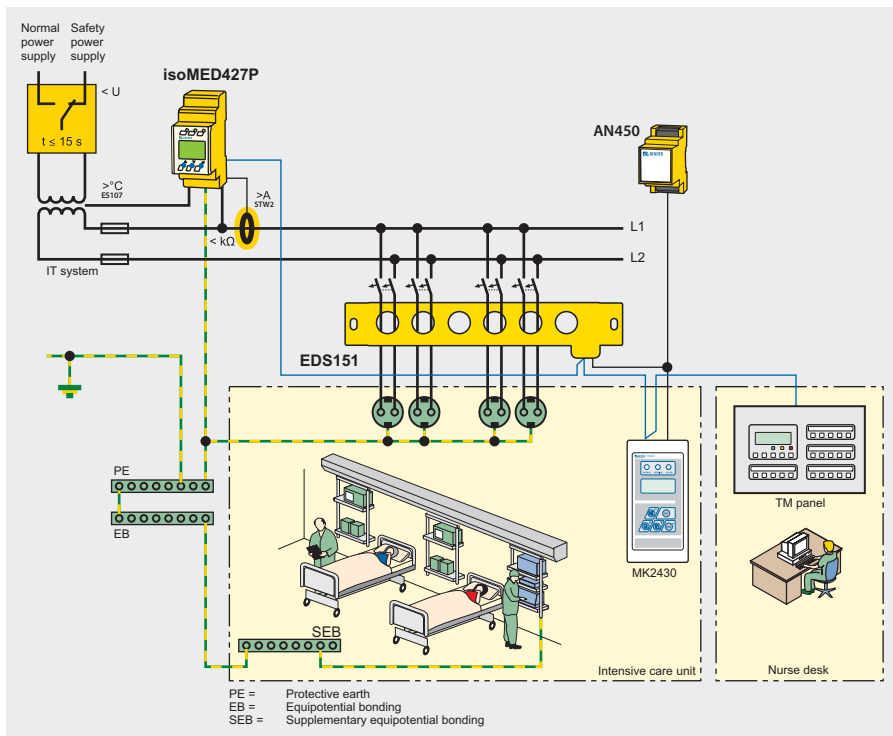

## Insulation fault location in IT systems with the EDS151 system

In medical locations, IT systems with insulation monitoring are intended to supply medical electrical equipment. That ensures reliable power supply, even when a first fault occurs. In addition a fast location and elimination of the insulation fault is required. Particularly in the view of the variety of electrical equipment (e. g. socket outlet circuits) used in intensive care units, insulation fault location is disruptive and costly in terms of time and money. The EDS151 insulation fault location system is the modular solution for this problem. It facilitates precise localisation of insulation faults without disruption to the operation of the power system.

EDS151 insulation fault location system applied in an intensive care unit

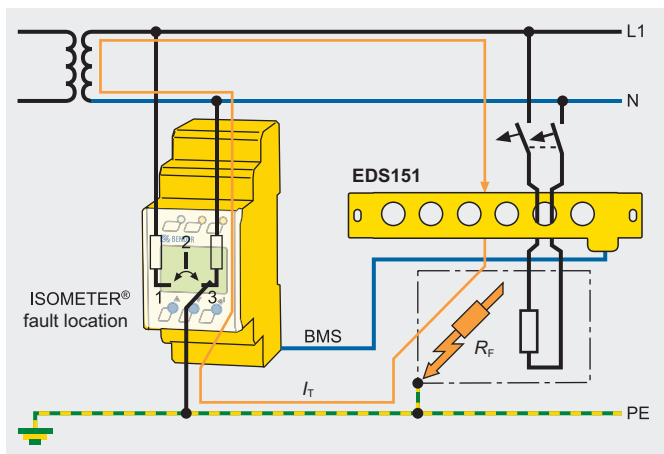

Function principle of the EDS151 system

### Advantages:

- Insulation fault location during operation
- Fast localisation of faulty circuits/equipment
- Reduced maintenance costs
- Central indication via LC text display at remote alarm indicator and operator panels.

### System functions:

- Indication of faulty branch circuits.
- Easily retrofitting with existing installations due to the modular design.
- Measuring current transformers in different sizes and designs.
- Up to 528 sub circuits can be monitored.
- Communication via two-wire connection.
- Universally applicable for all IT systems.

### Function principle:

The EDS151 system works in combination with a central insulation monitoring device with integrated pulse generator, e. g. an ISOMETER® isoMED427P. After an insulation fault the isoMED427P starts automatically the fault location by generating a test signal. Its amplitude and duration are limited. The signal flows via the location of the insulation fault and through all measuring current transformers within the insulation fault path. The EDS151 system scans all measuring current transformers.

The EDS151 with its LEDs or the central control and indicating device (e.g. MK2430) provide fault location information.



# What else can you do for increased safety?

## Residual current monitoring for TN-S systems

### TN-S systems: advance information with RCM and RCMS

In order to avoid leakage currents, the IEC 60364-7-710 recommends the installation of the TN-S system (five conductors) downstream of the main distribution board of the building. This standard also recommends to monitor the system in order to ensure a high insulation level of all conductors in group 0 and 1 rooms.

For fulfilling the task of monitoring, the use of RCM (residual current monitors) respectively RCMS (residual current monitoring systems), which detect and indicate fault currents at an early stage instead of unintentional switching off, has proved to be successful.

**According to IEC 60364-7-710: 2002-11, the use of the TN-S system (earthed system) in medical locations of Group 2 is restricted to the supply of:**

- Circuits for the supply of operating tables.
- Circuits for X-ray units.
- Circuits for large equipment with a rated power greater than 5 kVA.
- Circuits for non-critical electrical equipment (non life support).

### Advantages:

- Prewarning before unexpected interruptions occur, prevention of fire risks and damage to property.
- Convenient monitoring of the electrical installation from a central control room.
- Adjustment to the system ambient conditions by individual adjustable response values.

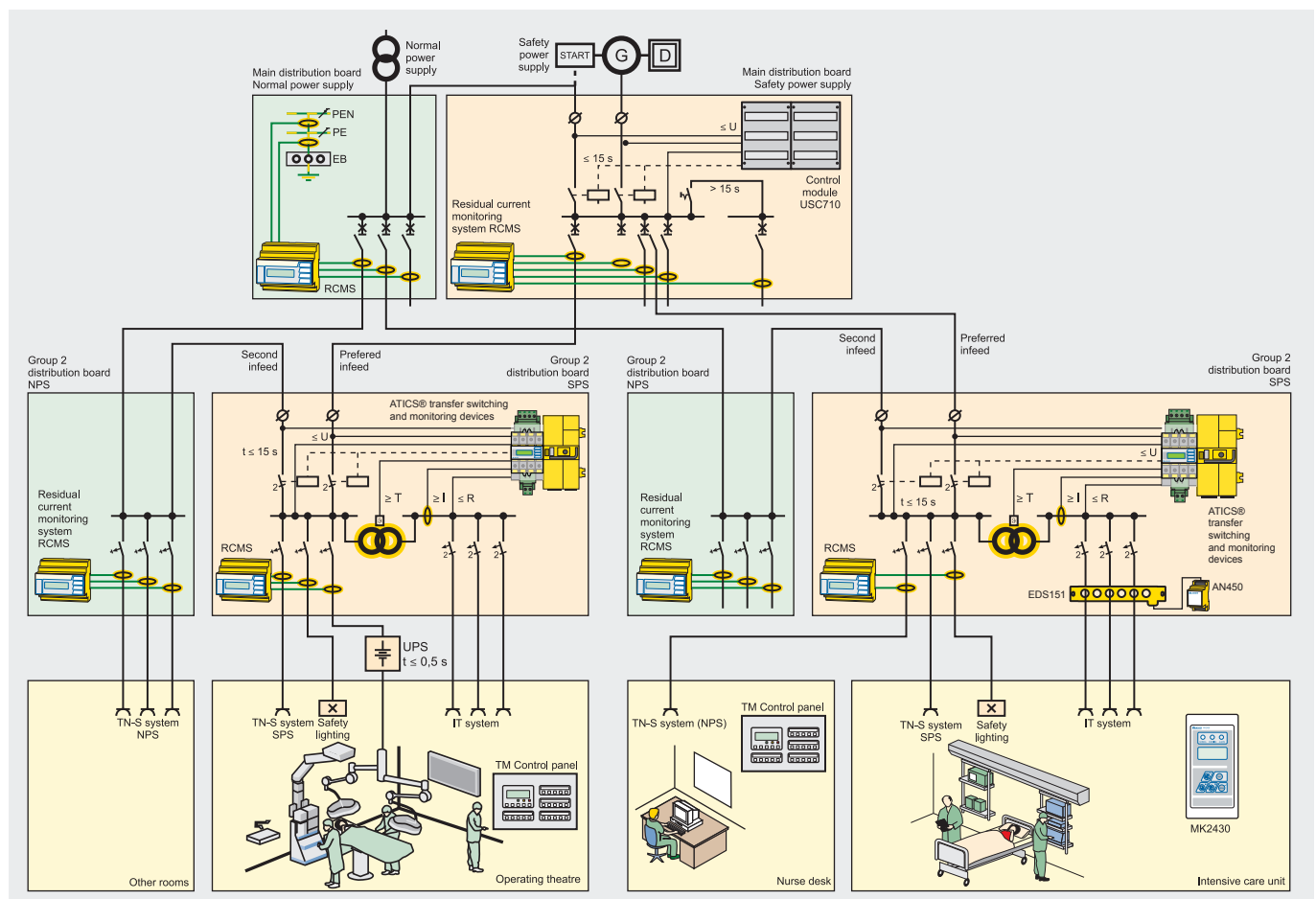

RCMS system in a hospital

NPS = Normal power supply – SPS = Safety power supply

<b>The complete solutions</b> .....	16
<b>ISOMETER® IR427 + MK7</b>	
Insulation-, load- and temperature monitoring device .....	18
<b>ISOMETER® isoMED427P</b>	
Insulation-, load- and temperature monitoring device .....	20
<b>ISOMETER® IR426-D47</b>	
Insulation monitoring device for operating theatre lamps .....	22
<b>MK2007</b>	
Remote alarm indicator and test combination .....	24
<b>MK2430</b>	
Remote alarm indicator and test combination .....	26
<b>LINETRAXX® CMS460-D4-2</b>	
Three phase loads monitoring .....	28
<b>Alarm and control panels</b> .....	30
<b>ATICS®</b>	
Transfer switching and monitoring devices .....	32
<b>IT System Distribution Boards</b>	
for Operating Theatre and Intensive Care .....	34
<b>EDS151</b>	
Insulation fault location system .....	35
<b>EDS461</b>	
Insulation fault location system .....	36
<b>Power supply units</b> .....	37
<b>ES710</b>	
Single-phase isolating transformer .....	40
<b>DS0107</b>	
Three-phase isolating transformer .....	41
<b>LINETRAXX® Power Quality and Energy Measurement</b>	
For transparency in electrical installations .....	42
<b>Bender communication solutions</b> .....	44
<b>References</b> .....	46

# The complete solutions

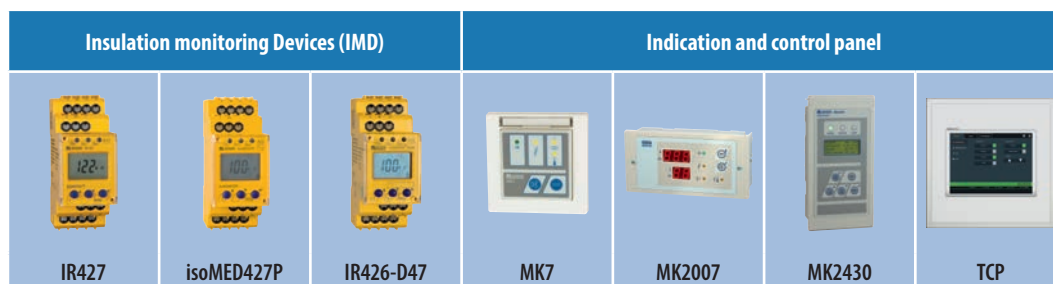

Page		18	20	22	18	24	26	30
System	1ph	■	■	–	–	–	–	–
	3ph	–	CMS460-D4-2	–	–	–	–	–
Monitoring	Insulation	■	■	–	■	■	■	■
	Overload	■	■	–	■	■	■	■
	Temperature	■	■	–	■	■	■	■
	Fault location	–	■	–	–	■	■	■
	Changeover	–	–	–	–	–	■	■
Indication	LED	■	■	■	■	■	■	–
	Text display	–	–	–	–	–	Dot matrix	Grafik
	7-Segment	■	■	■	–	■	–	–
	Data logging	–	–	–	–	–	■	■
	Individual text	–	–	–	–	–	■	■
Communication	BMS	–	■	–	–	■	■	■
	4-wire	■	–	–	■	–	–	–
	TCP/IP	–	–	–	–	–	–	–
	Modbus RTU	–	–	–	–	–	–	–
	Modbus TCP	–	–	–	–	–	–	–
Power supply units	AN450	–	–	–	–	■	■	–
	ESL0107	–	–	■	–	–	–	–
Transformer for operating theatre lamps	ES710	■	■	–	–	–	–	–
	DS0107	–	■	–	–	–	–	–
		–	–	–	–	–	–	–



Three phase loads	Change-over	Insulation fault location system		Isolating transformer		Power Quality and Energy Measurement		Communication solutions
								
CMS460-D4-2	ATICS®	EDS151	EDS461	ES710	DS0107	PEM...	CP700	COM465XX

28	32	35	36	40	41	42	42	44
-	■	-	-	■	-	■	■	■
■	■	-	-	-	■	■	■	■
-	■	-	-	-	-	-	■	■
■	■	-	-	-	-	-	■	■
-	■	-	-	-	-	-	■	■
-	■	■	■	-	-	-	■	■
-	■	-	-	-	-	-	■	■
■	■	-	-	-	-	■	■	■
Grafik	■	-	-	-	-	■	■	-
-	-	-	-	-	-	■	-	-
-	■	-	-	-	-	■	■	■
-	-	-	-	-	-	-	■	■
■	■	■	■	-	-	-	■	■
-	-	-	-	-	-	-	-	-
-	-	-	-	-	-	-	■	■ <sup>1)</sup>
-	-	-	-	-	-	■	■	■ <sup>3)</sup>
-	-	-	-	-	-	■	■	■ <sup>2)</sup>
-	-	■	-	-	-	-	-	-
-	-	-	-	-	-	-	-	-
-	-	-	-	-	-	-	-	-
■	-	-	-	-	-	-	-	-

1) only COM465XX  
2) only COM461MT  
3) only COM462RTU

# ISOMETER® IR427 + MK7

## Insulation-, load- and temperature monitoring device



ISOMETER® IR427 + MK7

The ISOMETER® of the IR427 series is designed to monitor the insulation resistance of AC circuits (medical IT systems). At the same time, the load current and temperature of the IT system transformer can be monitored.

### Features:

#### ISOMETER® IR427

- Insulation monitoring for medical IT systems
- Load and temperature monitoring for IT system transformers
- Adjustable response value for insulation monitoring
- Adjustable load current response value
- Integrated voltage supply for four alarm and test combinations MK7
- Temperature monitoring with PTC thermistor or bimetal switch
- Connection monitoring earth
- LEDs: Power On, Alarm 1, Alarm 2
- Internal/external test button
- Configurable alarm relay: N/O or N/C operation selectable
- Self monitoring with automatic alarm
- Compact two-module enclosure (36 mm)
- Four-wire interface for four alarm indicator and test combinations MK7
- AMP measuring principle for monitoring AC with galvanically connected DC systems (e.g. in power supplies)

#### Remote alarm indicator and test combination MK7

- Easy-to-clean front foil surface
- Label field
- Panel frame alpine white
- Alarm LEDs: Power On, insulation fault overload, overtemperature
- Test button, mute button
- Standard flush-mounting enclosure 66 mm

#### Standards:

The ISOMETER® of the IR427 series complies with the requirements of the device standards:  
IEC 60364-7-710, IEC 61557-8, AnnexA: 2007-01 and DIN VDE 0100-710.

### Technical data

Rated impulse voltage	4 kV
Supply voltage $U_S$	AC 70...264 V, 42...460 Hz

#### Insulation monitoring

Response value $R_{an}$	50...500 k $\Omega$
Relative uncertainty	$\pm 10\%$
Hysteresis	25 %
Response time $t_{an}$ at $R_F = 0.5 \times R_{an}$ and $C_e = 0.5 \mu F$	$\leq 5$ s
Permissible system leakage capacitance $C_e$	$\leq 5 \mu F$

#### Load current monitoring

Response value, adjustable	5...50 A
----------------------------	----------

#### Temperature monitoring

Response value (fixed value)	4 k $\Omega$
Release value (fixed value)	1.6 k $\Omega$
PTC resistors acc. to DIN 44081	max. 6 in series

#### Interface for MK7

Cable length, twisted in pairs, shielded	200 m
Cable (twisted in pairs, one end of shield connected to PE)	recommended: J-Y(St)Y min. 2x0.8

#### Power supply (terminals 1 and 2):

$U_{off}$	DC 24 V
$I_{max}$ (max. 4 MK7)	80 mA

#### Communication (terminal 3 and 4):

Interface/protocol	RS-485/proprietary, no BMS
Terminating resistor	120 (0.25 W), internal, switchable

#### Test of the Electromagnetic Compatibility (EMC)

EMC	IEC 61326-2-4
Operating temperature	-25...+55 °C

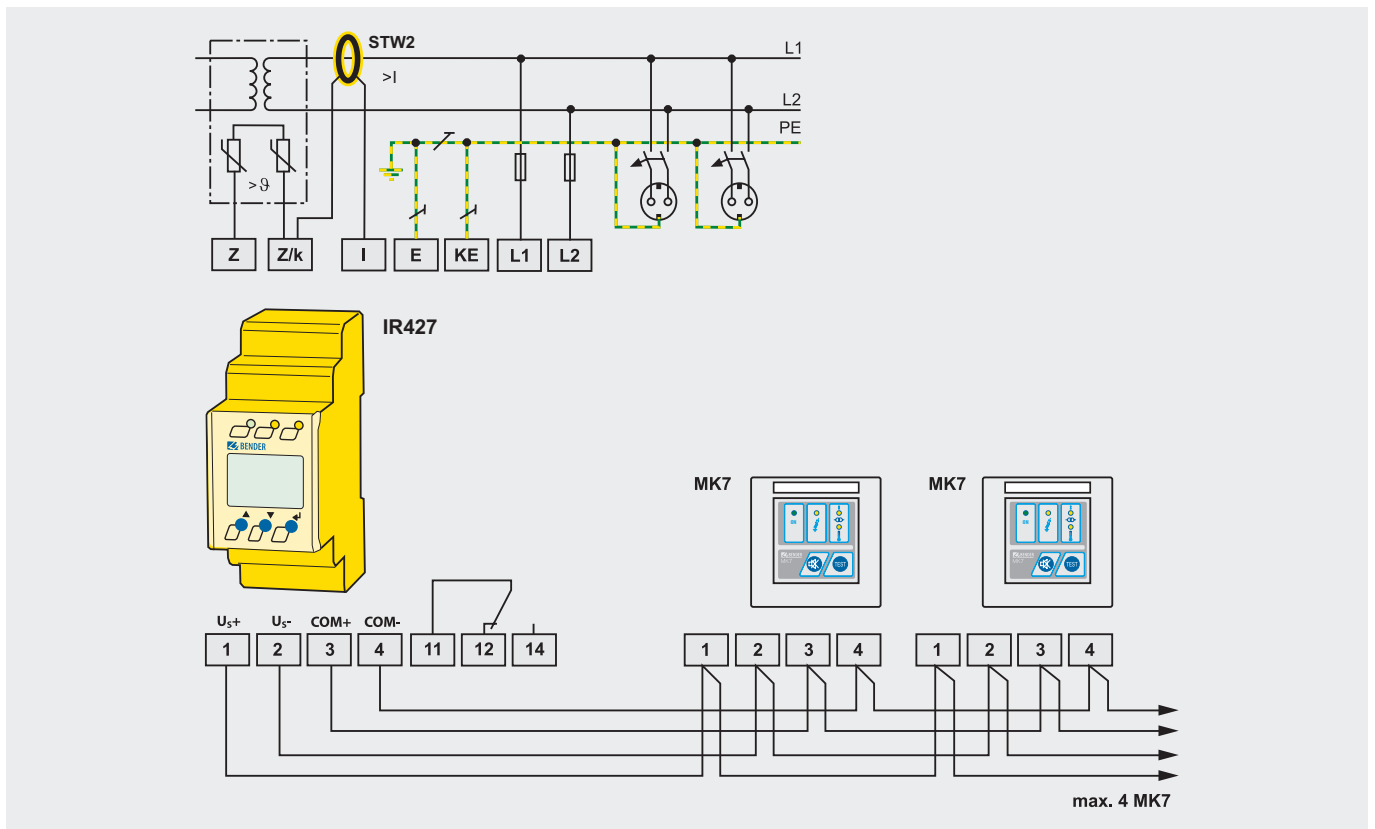

Wiring diagram IR427 + MK7

### Ordering information

Supply voltage $U_s$		Type	Art. No.
AC	DC		
70...264 V 42...460 Hz	–	IR427-2	B 7207 5300
–	18...28 V	MK7	B 9510 0201

<sup>1)</sup> Absolute values

### Accessories

Type designation	Art. No.
Mounting clip for screw mounting (1 piece per device)	B 9806 0008
MK-cavity-wall-box-60mm	B 95100203
Mounting frame XM420	B 990 994

### Suitable system components

Type designation	Type	Art. No.
Measuring current transformers	STW2	B 942 709
Temperature sensor (PTC)	ES0107	B 924 186

# ISOMETER® isoMED427P

## Insulation-, load- and temperature monitoring device (insulation fault location integrated)



ISOMETER® isoMED427P

### Features:

- Insulation monitoring for medical IT systems
- Adjustable response value for insulation monitoring
- Locating current injector for insulation fault location systems
- Load and temperature monitoring for IT system transformers
- Adjustable load current response value
- Temperature monitoring with PTC thermistor or bimetal switch
- Self monitoring with automatic alarm
- PE connection monitoring
- Internal/external test button
- LEDs: Power On, Alarm 1, Alarm 2
- Configurable alarm relay: N/O or N/C operation selectable
- Compact two-module enclosure (36 mm)
- BMS interface
- AMP measuring principle for monitoring AC with galvanically connected DC systems (e.g. in power supplies)

### Standards:

The ISOMETER® of the isoMED427P series complies with the requirements of the device standards: IEC 60364-7-710, IEC 61557-8, AnnexA: 2007-01, IEC 61557-9 and DIN VDE 0100-710.

The ISOMETER® isoMED427P monitors the insulation resistance of unearthed AC circuits which may also contain DC components (medical "IT systems"). At the same time, the load current and temperature of the IT system transformer is monitored. In combination with EDS series insulation fault locators and the appropriate measuring current transformers, the isoMED427P is designed to set up the respective equipment for insulation fault location.

### Technical data

Rated impulse voltage	4 kV
Supply voltage $U_S$	AC 70...264 V, 47...63 Hz

### Insulation monitoring acc. to IEC 61557-8

Response value $R_{an}$	50...500 k $\Omega$ (50 k $\Omega$ )*
Relative uncertainty	$\pm 10\%$
Hysteresis	25%
Response time $t_{an}$ at $R_f = 0.5 \times R_{an}$ and $C_e = 0.5 \mu F$	$\leq 5$ s
Permissible system leakage capacitance $C_e$	5 $\mu F$
Fault location acc. to	IEC 61557-9
Test current	$\leq 1$ mA

### Measuring circuit

Measuring voltage $U_m$	$\pm 12$ V
Measuring current $I_m$ (at $R_f = 0 \Omega$ )	$\leq 50 \mu A$
Internal DC resistance $R_i$	$\geq 240$ k $\Omega$
Impedance $Z_i$ at 50 Hz	$\geq 200$ k $\Omega$
Permissible extraneous DC voltage $U_{fg}$	$\leq$ DC 300 V

### Load current monitoring

Response value, adjustable	5...50 A (7 A)*
Relative uncertainty	$\pm 5\%$
Hysteresis	4%
Nominal frequency $f_n$	47...63 Hz
Setting values load current measurement:	
Transformer	3150 VA    4000 VA    5000 VA    6300 VA    8000 VA    10000 VA
/alarm 1~	14 A    18 A    22 A    28 A    35 A    45 A

### Interface

Interface/protocol	RS-485/BMS
Baud rate	9.6 kbit/s
Cable length	$\leq 1200$ m
Cable (twisted in pairs, one end of shield connected to PE)	recommended: J-Y(St)Y min. 2x0.8
Terminating resistor	120 (0.25 W), internal, switchable
Device address, BMS bus	2...90

### Test of the Electromagnetic Compatibility (EMC)

EMC	IEC 61326-2-4
Operating temperature	-25...+55 °C

( ) \* factory setting

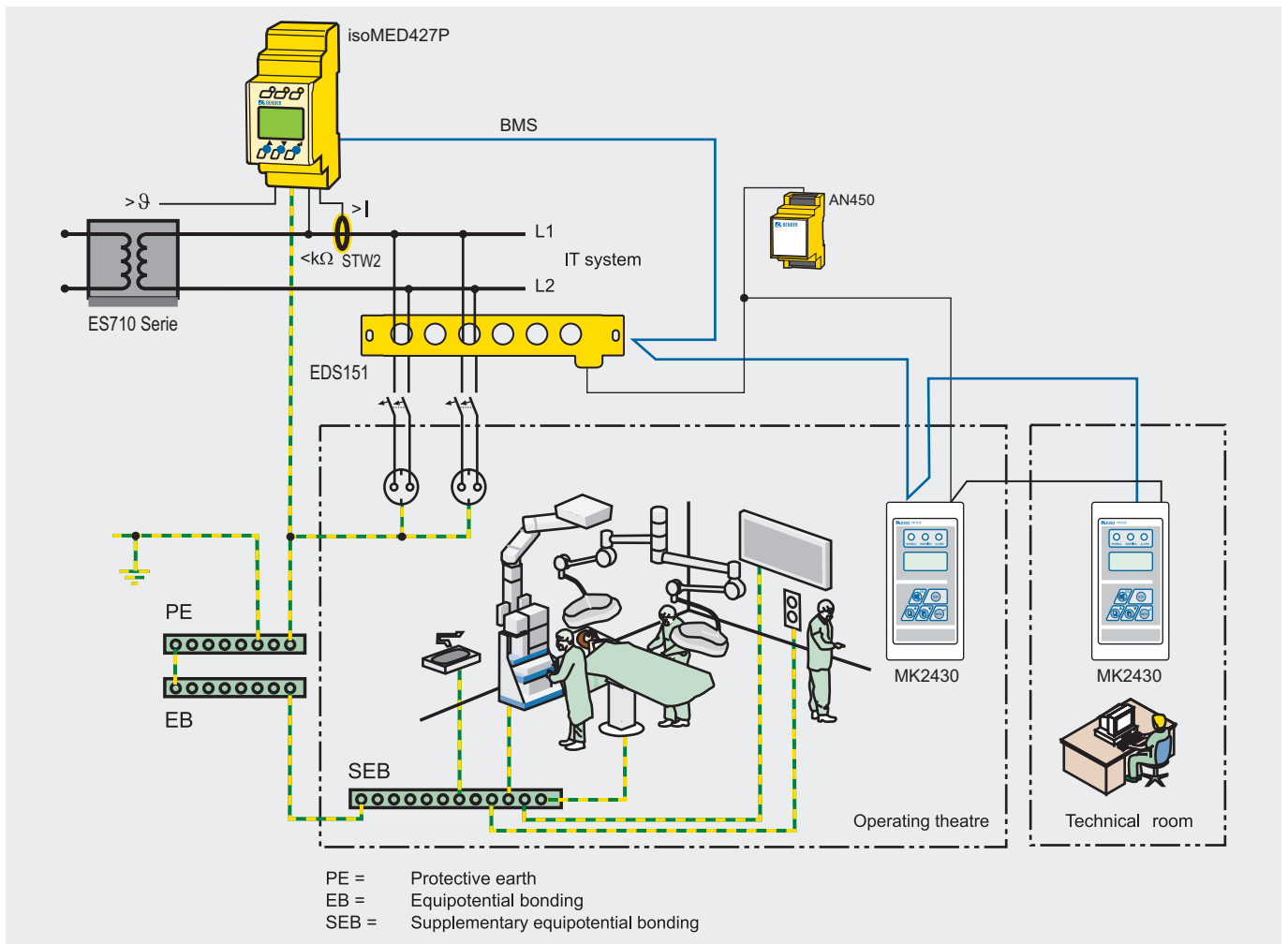

Function principle of isoMED427P

### Ordering information

Supply voltage $U_S = U_n^{1)}$	Type	Art. No.
AC	isoMED427P-2	B 7207 5301
70...264 V, 47...63 Hz		

<sup>1)</sup> Absolute values of the voltage range

### Accessories

Type designation	Art. No.
Mounting clip for screw mounting (1 piece per device)	B 9806 0008
Mounting frame XM420	B 990 994

### Suitable system components

Type designation	Type	Page
Measuring current transformers	STW2	B 942 709
Temperature sensor (PTC)	ES0107	B 924 186

# ISOMETER® IR426-D47

## Insulation monitoring device for operating theatre lamps



ISOMETER® IR426-D47

The ISOMETER® IR426-D47 monitors the insulation resistance of IT systems (isolated power) for operating theatre lamps.

### Features:

- For DC/AC IT systems 0...132 V
- Response value 10...200 kΩ
- Built-in test button
- Built-in Power On and alarm LED
- Two alarm relays with changeover contacts

### Standards:

The ISOMETER® IR426-D47 complies with IEC 61557-8: 2001-01 + Corrigendum 2007-05, DIN EN 61557-8 (VDE 0413-8): 2001-12, ASTM F 1669M-96 (2002). When installing the device, the safety instructions supplied with the equipment must be observed!

### Ordering information

Supply voltage <sup>1)</sup> U <sub>S</sub>		Type	Art. No.
AC	DC		
70...300 V, 15...460 Hz	70...300 V	IR426-D47	B 7101 6307

### Accessories

Type designation	Art. No.
Mounting clip for screw mounting (1 piece per device)	B 9806 0008

### Suitable system components

Type designation	Type	Art. No.
Isolating transformer for operating theatre lamps	ESL0107-0	B 924 204

### Technical data

#### Insulation coordination acc. to IEC 60664-1/IEC 60664-3

Rated insulation voltage	AC 250 V
Rated impulse withstand voltage/contamination level	4 kV/3

#### Voltage range

Operating range of U <sub>n</sub>	AC 0...132 V/DC 0...132 V, 42...62 Hz
-----------------------------------	---------------------------------------

#### Supply voltage

Supply voltage U <sub>S</sub>	AC 70...300 V, 15...460 Hz/DC 70...300 V
Power consumption	≤ 4 VA

#### Response value

Response value R <sub>an1</sub> (Alarm 1)	10...200 kΩ (50 kΩ)*
Response value R <sub>an2</sub> (Alarm 2)	10...200 kΩ (50 kΩ)*
Relative uncertainty	± 15 %
Hysteresis	25 %

#### Measuring circuit

Measuring voltage U <sub>m</sub>	± 12 V
Measuring current I <sub>m</sub> (at R <sub>F</sub> = 0 Ω)	≤ 100 μA
Internal DC resistance R <sub>i</sub>	≥ 120 kΩ
Impedance Z <sub>i</sub> at 50 Hz	≥ 117 kΩ
Permissible extraneous DC voltage U <sub>fg</sub>	≤ DC 132 V
Permissible system leakage capacitance C <sub>e</sub>	≤ 20 μF

#### Test of the Electromagnetic Compatibility (EMC)

EMC	IEC61326-2-4
Operating temperature	-25...+55 °C

( )\* factory setting

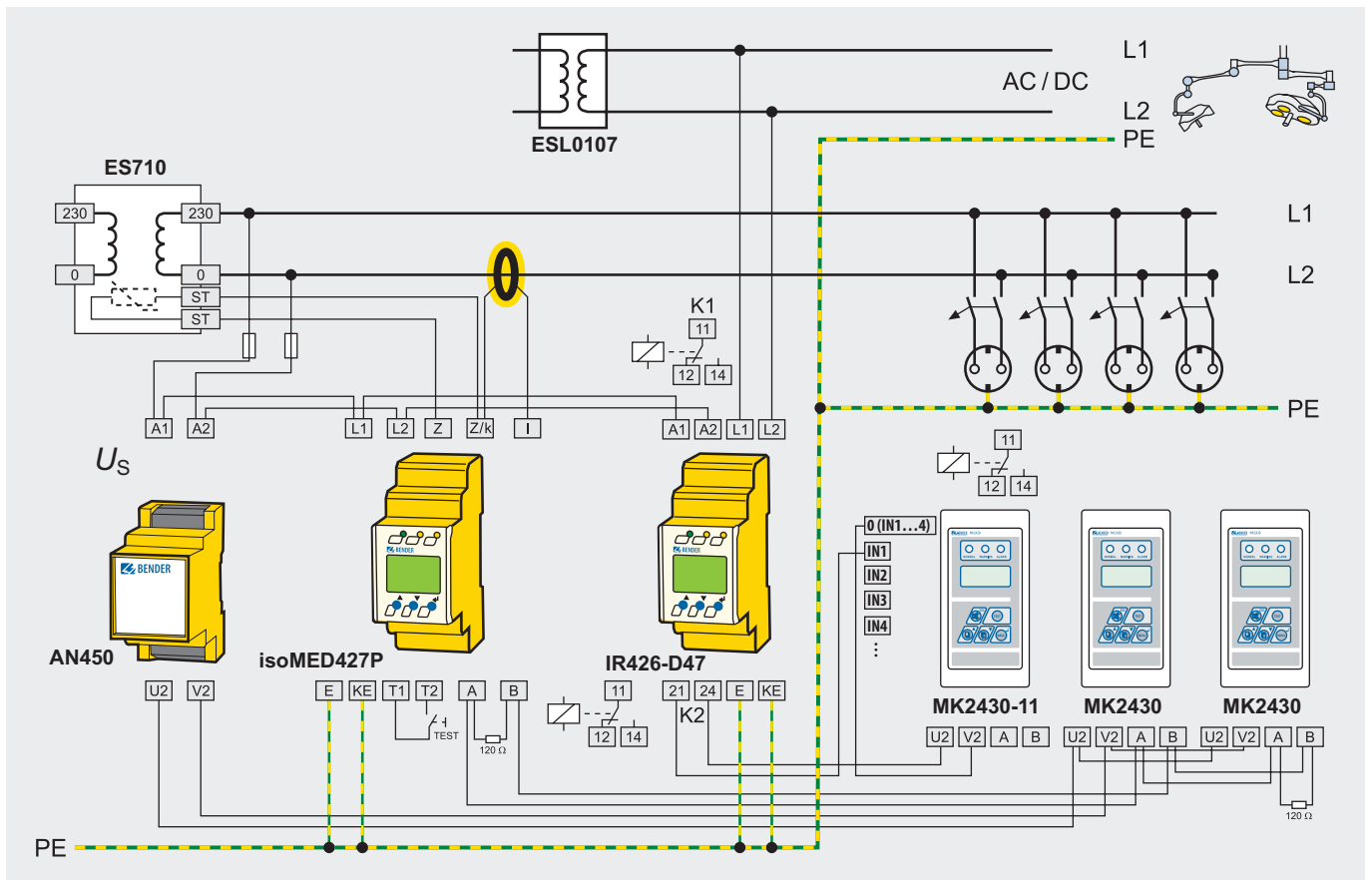

Example of a monitoring system for IT systems and operating theatre luminaires circuits in medical locations according to IEC 60364-7-710 and DIN VDE 0100-710

# MK2007

## Remote alarm indicator and test combination



The MK2007 remote alarm indicator and test combination duplicates fault, alarm and operating messages of monitoring devices in accordance with IEC 60364- 7-710: 2002-11 and DIN VDE 0100-710 (VDE 0100-710): 2002-11. The insulation resistance in kΩ (3 digits) and the percentage value of the load current (2 digits) are clearly indicated by a seven-segment display. A two-wire connection between the MK2007 remote alarm indicators and the changeover and monitoring modules allows a time and cost-saving installation.

MK2007

### Features:

- Clear digital display for the indication of the insulation resistance and the load current values
- Time and cost-saving installation via a two-wire connection
- Easy-to-clean lexan front foil
- Simple parallel indication through two-wire interface

### Technical data:

Supply voltage $U_s$	AC/DC 12...28 V, 50...60 Hz
Seven-segment display	12 mm high
Insulation resistance	3 digits
Load current	2 digits
Audible buzzer	one

### Inputs/outputs:

Serial interface	RS-485 (BMS protocol)
Wire length	≤ 1200 m
Power On and alarm LEDs to signal	operation, overload, overtemperature, insulation fault
Buttons	test insulation monitor, mute

### Test of the Electromagnetic Compatibility (EMC):

Interference emission acc.	to EN 61000-6-2
Emissions acc. to EN 55011 / CISPR11	Class B
Ambient temperature during operation	-5...+55 °C



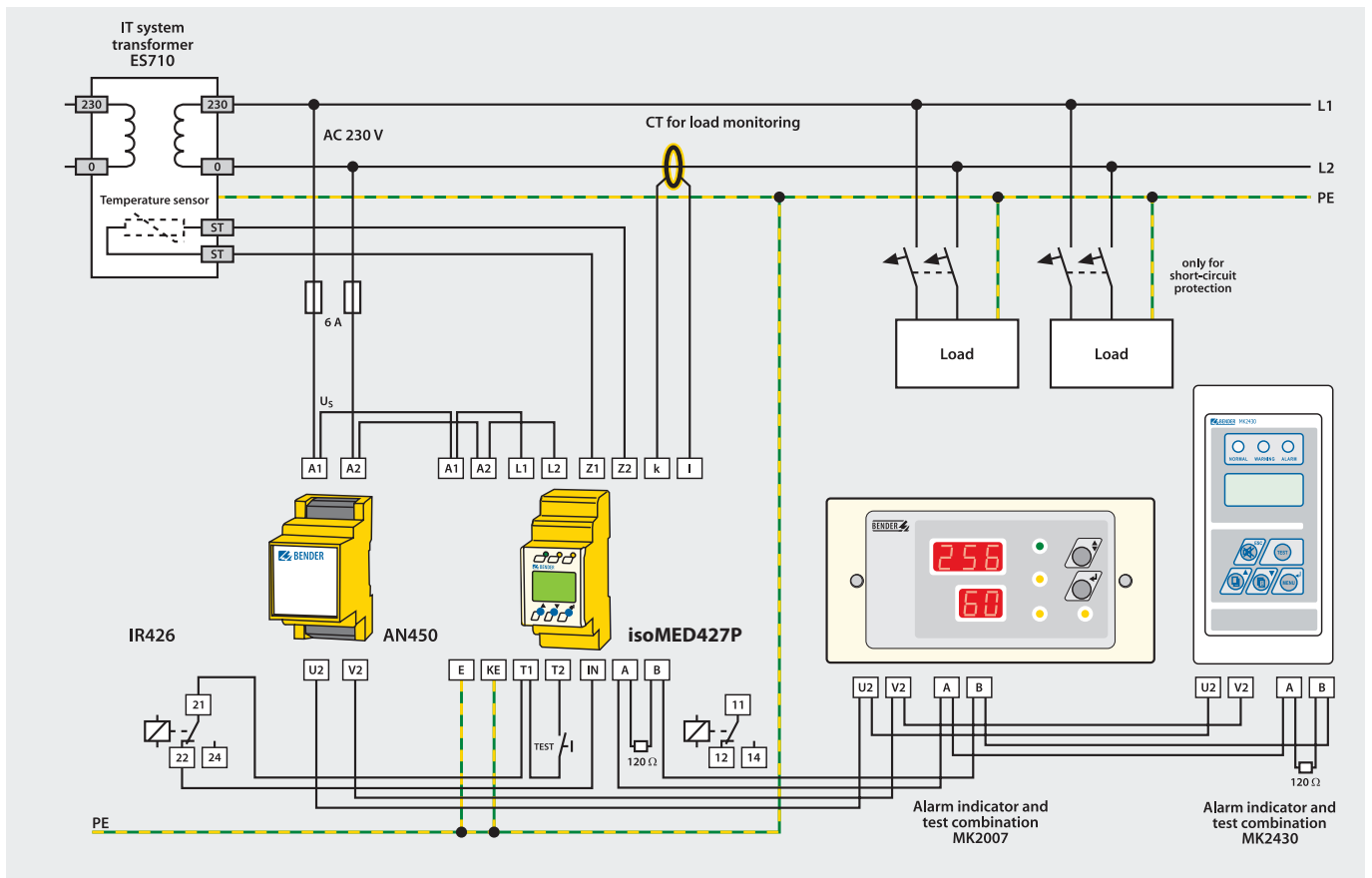

IT system with insulation, load and temperature monitoring device isoMED427P as well as remote alarm indicator and test combination MK2007/MK2430

### Ordering details

Type designation	Type	Art. No.
Alarm indicator and test combination (front foil with symbols)	MK2007CBM	B 923 813
Remote alarm indicator and test combination (front foil with text)	MK2007CBMT	B 923 801

### Suitable system components

Type designation	Type	Art. No.
Power supply	AN450	B 924 201

# MK2430

## Remote alarm indicator and test combination



The remote alarm indicator and test combination duplicates fault, alarm and operating messages of monitoring devices in accordance with IEC 60364-7-710: 2002-11 and DIN VDE 0100-710 (VDE 0100-710): 2002- 11. The LC text display provides medical staff with clear and concise information. Additional information for the technical staff can be retrieved by pressing a special button. A two-wire connection between the MK2430 remote alarm indicators and the changeover and monitoring modules allows a time and cost-saving installation.

### Typical applications:

- Intensive care unit with several IT systems and EDS
- Operating theatres
- Industrial applications with EDS/RCMS

### Features:

- Comprehensive information: suitable for utilisation with MEDICS (isoMED427P, 107TD47) or EDS/RCMS systems
- Programmable display of customised alarms
- Signalling of medical gases messages in compliance with the relevant standards (-11 version)
- Display of test possibilities for several IT systems with evaluation and display of results
- Display of messages from UPS systems
- Individual texts for better information
- Display of messages from EDS/RCMS systems
- Standard configuration for four IT systems with EDS
- Easy-to-clean lexan front foil
- Simple parallel indication by two-wire connection
- Available for flush-mounting, surface-mounting and cable-duct mounting

### Technical data:

Supply voltage $U_s$	AC 18...28 V/40...60 Hz/DC 19...30 V
LC display, illuminated	4 x 20 characters

### Inputs (MK2430-11 only):

Digital inputs	12
Voltage range (high)	AC/DC 15...30 V
Voltage range (low)	AC/DC 0...2 V

### Interfaces:

Serial interface	RS-485 (BMS protocol)
Wire length	≤ 1200 m
USB	V 2.0/V 1.1

### Test of the Electromagnetic Compatibility (EMC):

EMC immunity	to EN 61000-6-2
EMC emission	to EN 61000-6-3
Ambient temperature during operation	-5...+55 °C

### Relay (MK2430-11 only):

Switching elements	1 changeover contact
Operating principle, adjustable	N/C operation
Rated operational voltage	24 V AC/DC
Function	programmable (test, fault, device failure)
Programming software	TMK-Set V4.x optional

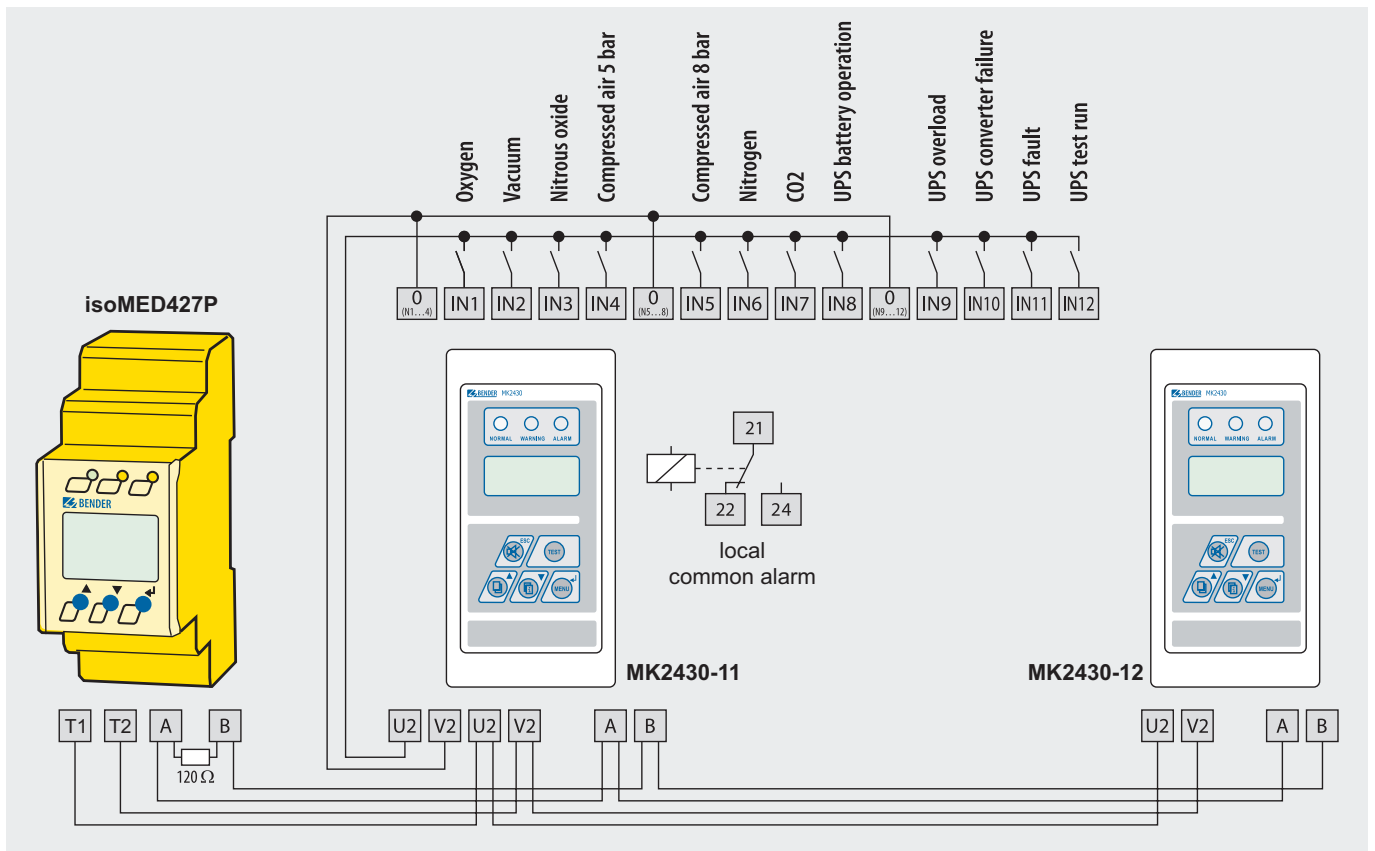

isoMED427P Insulation-, load- and temperature monitoring device, MK2430-12 and MK2430-11 remote alarm indicator and test combination with 12 digital inputs for the communication of additional data

### Ordering information

Enclosure	Digital inputs/ relay output	Type	Art. No.
Flush-mounting	12/1	MK2430-11	B 9510 0031
	–	MK2430-12	B 9510 0032
Surface mounting	12/1	MK2430A-11	B 9510 0035
	–	MK2430A-12	B 9510 0036

### Accessories

Type designation	Type	Art. No.
Parameterisation software	TMK-SET	as Internet download
MK2430-mounting kit, complete		B 9510 1000

### Suitable system components

Type designation	Type	Art. No.
Power supply	AN450	B 924 201

# Three phase loads monitored by LINETRAXX® CMS460-D4-2



LINETRAXX® CMS460-D4-2

## Features:

- Three r.m.s. measuring channels for the three load currents of three phase transformers
- Calculation of the maximum load of the three measured values
- Selectable nominal transformer load current 1 A ... 32 A (63 A)
- STW2/STW3/STW4 CTs selectable
- Response ranges 1 A...32 A (63 A) (42...2000 Hz)
- Alarm on channel 4 if 100 % of transformer load current is reached or exceeded on at least one of the channels 1...3
- Adjustable time delays
- History memory with date and time stamp for 300 data records/channel
- Data logger for 300 data records/channel
- Analysis of the harmonics, THD
- Two alarm relays with one changeover contact each
- N/O or N/C operation and fault memory selectable
- Connection for external test and reset button
- Backlit graphical display (7-segment display) and alarm LEDs
- Data exchange via BMS bus
- Password protection for device setting
- RoHS compliant

## Standards:

DIN VDE 0100-710 (VDE 0100-710):2012-10\*, DIN VDE 0100-718 (VDE 0100-718):2005-10, ÖVE/ÖNORM E 8007:2007-12\*, IEC 60364-7-710:2002-11

The CMS460-D4-2 is a device for load monitoring with 3-phase insulating transformers.

It calculates the maximum of the load current of the three input channels and gives it as a % value, compared with the nominal transformer load current. The current on the three input channels is available on the BMS bus; also the load in % of the nominal transformer load current is available on channel 4. If the nominal load is reached or exceeded, then an alarm will be generated on channel 4 on the BMS bus and the relay will be activated.

The measured currents can be analyzed for harmonics.

## Insulation coordination acc. to IEC 60664-1/IEC 60664-3

Rated impulse voltage/pollution degree	4 kV/3
Supply voltage	see ordering information

## Measuring circuit

Number of measuring channels	3
External measuring current transformer	STW2/STW3/STW4
Measuring range	1 A ... 110 A
Rated operating current $I_{n2}$ (alarm)	1 ... 63 A (1 A overcurrent)*
Start-up delay $t$ (start-up) per device	0 ... 99 s (3 s)*

## Displays, memory

LEDs	ON/ALARM
LC display	backlit graphical display
History memory	300 data records
Data logger	300 data records per measuring channel
Language	D, GB, F (GB)*

## Inputs/outputs

Test/reset button	internal/external
-------------------	-------------------

## Interface

Interface/protocol	RS-485/BMS
Baud rate	9.6 kbit/s
Cable length	≤ 1200 m
Cable (twisted in pairs, one end of shield connected to PE)	recommended: J-Y(St)Y min. 2x0.8
Terminating resistor	120 Ω (0.25 W) connectable via DIP switch
Device address, BMS bus	1 ... 90 (2)*

## Switching elements

Number	2 x 1 changeover contact
--------	--------------------------

## Environment/EMC

EMC	IEC 61326-1
Operating temperature	0 ... +55 °C

( ) \* factory setting

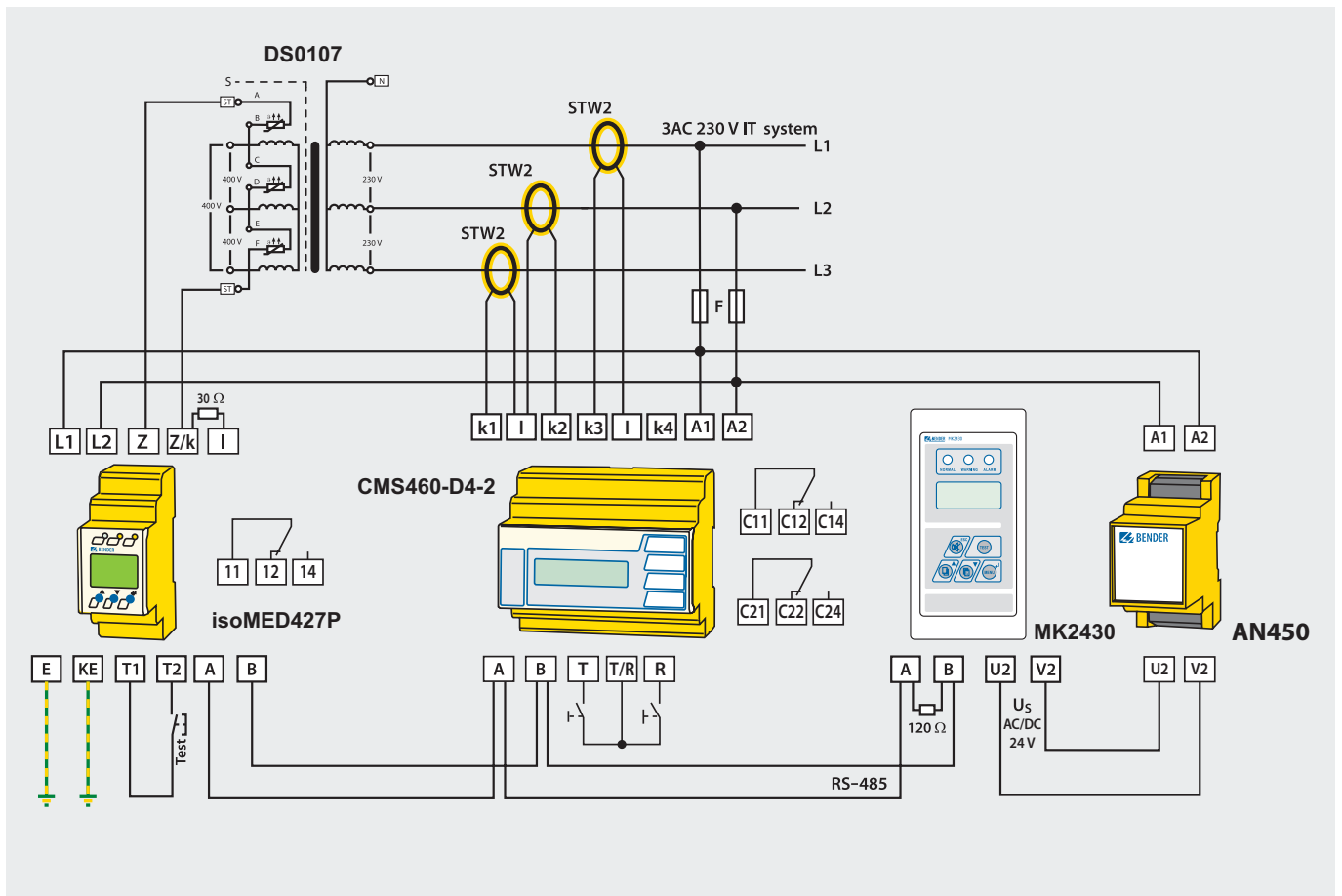

Wiring diagram isoMED427P/CMS460-D4-2

### Ordering details

Supply voltage $U_S$	Type	Art. No.
100...240 V	CMS460-D4-2	B 9405 3030

### Suitable system components

Type designation	Type	Art. No.
Current transformer	STW2	B 942 709
Current transformer	STW3	B 980 21000
Current transformer	STW4	B 980 21001
Temperature sensor	ES0107	B 924 186
Power supply	AN450	B 924 201

# Alarm and control panels



**TCP-series – Touch Control Panel**

## Features:

- High quality images with excellent contrast, high resolution and a wide optional viewing angle.
- Clear menu structure with self-explanatory images and screen elements.
- Standard texts and optional individually programmed in your language.
- Free programmable texts
- Supplementary information for medical and technical personnel.
- Easy-to-use, touch-sensitive control system for medical technology and other applications.
- Extremely straightforward user guidance for intuitive operation.
- Automatic plug 'n play software update
- Possibility of graphical integration of building floor plans or photo-quality status displays.



**TM-series**

## Features:

- Large, backlit text display indicates user-programmable alarm text messages and additional information.
- Character height 8mm, 8 lines, 20 characters each.
- Standard texts for messages in 20 languages.
- 1000 free programmable texts
- Three LEDs provide normal (green), warning (yellow), and alarm (red) indication.
- 5-way indicator push button modules can be programmed.
- Multiple TM control panels may be connected in parallel to the external or internal Bender BMS bus system.
- Programmable relay outputs, digital inputs and output options provide ease of connection to other systems.
- The alarm/warning/status text messages may be programmed via USB interface and PC software.



**FM-series w/digital timer and clock**

## Features:

- Small, backlit text display indicates user-programmable alarm text messages.
- Character height 5mm, four text lines with 20 characters each.
- Standard texts for messages in 20 languages.
- 200 free programmable texts
- Three LEDs provide normal (green), warning (yellow), and alarm (red) indication.
- 5-way indicator push button modules with volt-free contacts.
- Internal bus communication
- Relay outputs, digital inputs and output options provide ease of connection to other systems.
- The alarm/warning/status text messages may be programmed via USB interface and PC software.

## Common to all panels

- Flush mounted with bezel frame and surface mounted enclosures.
- Individual enclosure dimensions.
- Screwless mounting front plate.
- Closed foil surface allowing easy integration of third-party systems, for example, operating theatre table controls, medical gases, intercom systems, and many more.
- Panel front with unique life-long antibacterial foil surface.
- Alarm/warning messages are automatically stored with date and time stamp.
- Visual alarm, audible alarm can be muted.
- Easy retrofitting and expansion, with minimal service interruptions and system down time.
- Clearly labelled safety-related functions.

## Alarm indicator and operator panels

### Surgeon control panels

#### Variety of applications

- Healthcare facilities
- Industrial, residential and functional buildings

### Alarm indicator and operator panels

- Text display
- Membrane surface, anti bacterial

### Surgeon control panels

- Multifunctional
- Timer, clock
- X-Ray
- PACs



**Illuminated door signs**



**TM-series w/digital timer, analogue clock and medical gases alarm panel**



**SCP-TCP with 22" touch control, analogue clock, digital timer**



**TCP, 15" touch control screen, digital clock and timer, intercom, additional control push buttons**



**Two 22" PACS screens with keyboard**



**42" PACS screen**

# ATICS® transfer switching and monitoring devices

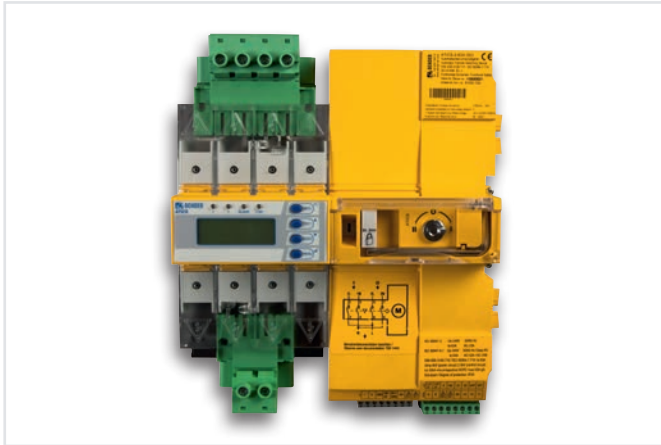

Transfer switching devices, 2 pole

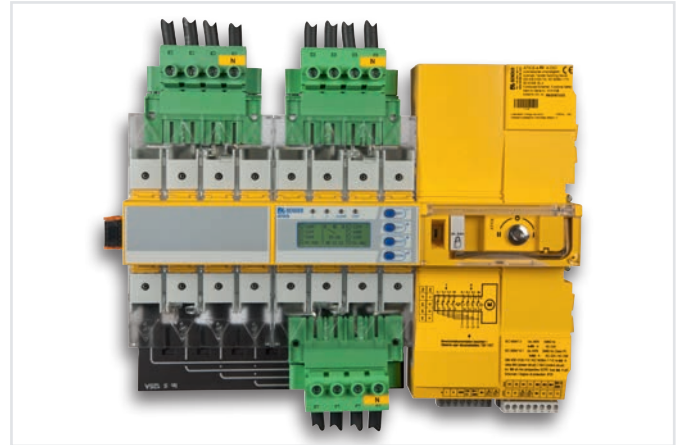

Automatic switching device for safety power supplies, 4 pole

## ATICS®, the safest and most compact all-in-one automatic transfer switching device in the world for safety-relevant areas and medical locations.

Power supplies for sensitive equipment must function safely and reliably even under fault conditions. The ATICS® switching devices provide all functions for changeover between two independent power supplies. ATICS® has been developed consistently according to the Functional Safety standards (SIL 2) guarantee highest reliability. The switching device is perfectly suitable for the power supply in safety-relevant areas, e.g.

- Group 2 medical locations according to IEC 60364-7-710 and DIN VDE 0100-710 (VDE 0100-710):2012-10
- Emergency power supplies
- Heating, air conditioning, ventilation, cooling
- EDP, computer centres
- Fire extinguishing and sprinkler systems

IEC 60364-7-710.536.101 requires a „safe separation“ between systems as defined in IEC 60364-5-536.2.2.4, which does not allow semiconductor devices to be used as isolating devices.

## Convincing advantages:

- All-in-one: Integration of switch disconnecter and control
- Functional safety SIL 2
- Safe operation
- Switch disconnecter contacts of robust design
- Mechanical locking
- Manual operation directly on the device
- Certification by TÜV SÜD
- Perfectly suitable for space-saving installation/retrofitting
- Convenient installation and commissioning
- Excellent communication and parameterisation options
- Plug connectors and optional bypass switch
- Uninterrupted maintenance
- Safe separation



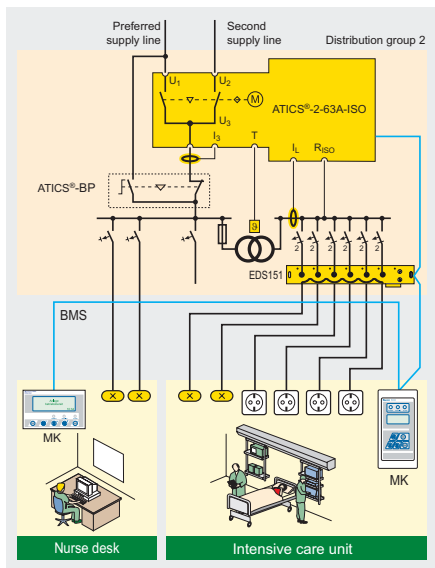

Changeover for intensive care units with integrated insulation fault location system (EDS) and bypass-switch

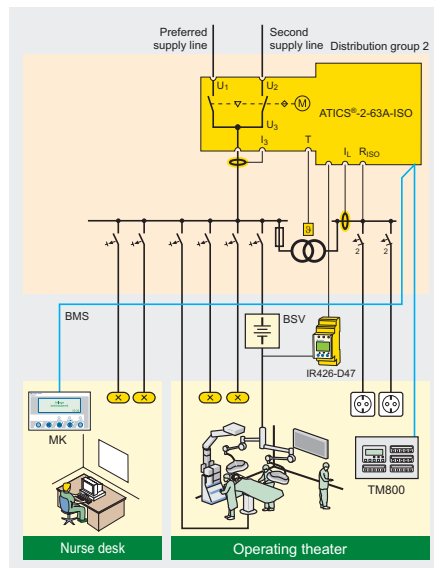

Changeover for operating theatres with operating theatre lights ISOMETER®

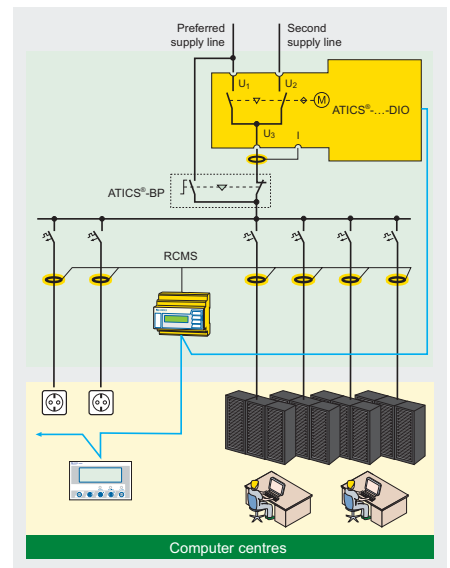

Changeover for safety-relevant environments with additional RCMS residual current monitoring system

### Ordering information

Designation	Rated operational current $I_e$	Scope of delivery	Type	Art. No.
2-pole switching and monitoring device	AC 63 A	1 x STW2, 1 x STW3, bridge, terminal cover, auxiliary contacts	ATICS-2-63A-ISO	B 9205 7202
	AC 80 A	1 x STW2, 1 x STW3, bridge, terminal cover, auxiliary contacts	ATICS-2-80A-ISO	B 9205 7203
2-pole switching device	AC 63 A	1 x STW3, bridge, connectors, terminal cover	ATICS-2-63A-DIO	B 9205 7212
	AC 80 A	1 x STW3, bridge, connectors, terminal cover	ATICS-2-80A-DIO	B 9205 7213
4-pole switching device	AC 80 A	3 x STW3, bridge, connectors, terminal cover	ATICS-4-80A-DIO	B 9205 7222
	AC 125 A	3 x STW4, bridge, connectors, terminal cover	ATICS-4-125A-DIO	B 9205 7223
	AC 160 A	3 x STW4, bridge, terminal cover	ATICS-4-160A-DIO	B 9205 7224
Bypass switch set	AC 63 A	Bridge, terminal cover, auxiliary contacts, LEDs green/red	ATICS-BP-3-63A-SET	B 9205 7252
	AC 80 A	Bridge, terminal cover, auxiliary contacts, LEDs green/red	ATICS-BP-3-80A-SET	B 9205 7253

# IT System Distribution Boards for Operating Theatre and Intensive Care



S-IPS-F/EDS with ATICS® Automatic changeover and monitoring device and Insulation fault monitoring

## IT System Distribution Boards

### S-IPS-F series

VIT-A series distribution boards are equipped with an isolating transformer as well as with a changeover and monitoring module including all necessary monitoring components as to DIN VDE 100-7010 and IEC 60364-7-710 for IT systems:

- Changeover device and voltage monitoring
- Insulation monitoring
- Load and temperature monitoring

The secondary side of the isolating transformer is equipped with at least 6 two-pole circuit breakers. Group 2 sockets are being connected to these.

In order to reduce or avoid noise disturbance by air circulating fans, waste heat is conducted by free convection.

### Device features

- Components
  - Automatic transfer switching device ATICS® including monitoring of i.e.:
    - Voltage of incoming supply
    - Output voltage
    - Correct operating times
    - Changeover times
    - Insulation resistance
    - Load current
    - Transformer temperature
  - At least 6 two-pole circuit breakers B16A
  - Isolating transformer (3150 VA – 10000 VA)
- Variable changeover time  $t \leq 0.5 \dots 15$  s
- Exchange of information by means of bus technology
- Connection facility for remote alarm indicator and operator panels TM800/MK800/MK2430/TCP
- Sheet steel housing as to DIN VDE 0100-710 (VDE 0100-710):2002-11, section 710.51.2.2
- Designed in accordance with the requirements of applicable standards
- Voluntary certification of changeover device by the independent German technical service, testing and inspection organisation (TÜV)

## IT System Distribution Boards

### S-IPS-F/EDS series

VIT-AFSBY series distribution boards are equipped with an isolating transformer as well as with a changeover and monitoring module including all necessary monitoring components as to DIN VDE 100-710 for IT systems:

- Changeover device and voltage monitoring
- Insulation monitoring
- Load and temperature monitoring
- Insulation fault locator
- Bypass Switch

The secondary side of the isolating transformer is equipped with at least 6 two-pole circuit breakers. Group 2 sockets are being connected to these.

In order to reduce or avoid noise disturbance by air circulating fans, waste heat is conducted by free convection.

### Device features:

- Components
  - Automatic transfer switching device ATICS® including monitoring of i.e.:
    - Voltage of incoming supply
    - Output voltage
    - Correct operating times
    - Changeover times
    - Insulation resistance
    - Load current
    - Transformer temperature
  - At least 6 two-pole circuit breakers B16A
  - Insulation fault monitoring device (EDS)
  - Bypass switch
  - Isolating transformer (3150 VA – 10000 VA)
- Variable changeover time  $t \leq 0.5 \dots 15$  s
- Exchange of information by means of bus technology
- Connection facility for remote alarm and operator panels TM800/MK800/MK2430/TCP
- Sheet steel housing as to DIN VDE 0100-710 (VDE 0100-710): 2002-11, section 710.51.2.2v
- Designed in accordance with the requirements of applicable standards
- Voluntary certification of changeover device by the independent German technical service, testing and inspection organisation (TÜV)

# EDS 151

## Insulation fault location system

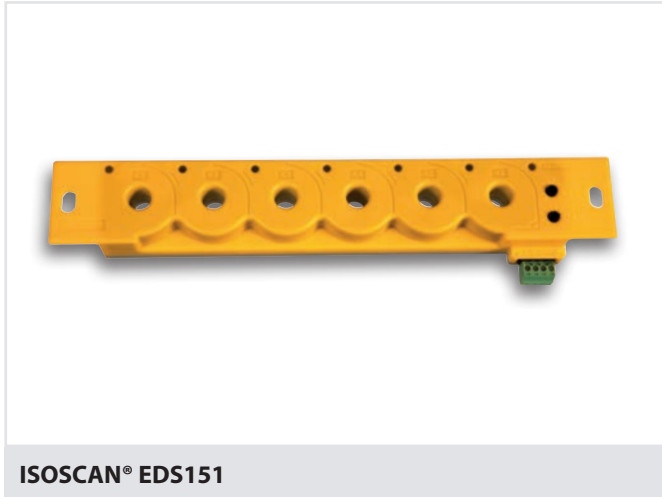

The insulation fault locator EDS151 in conjunction with the ISOMETER® isoMED427P or the locating current injector PGH, are designed for insulation fault location in unearthed power supplies (IT systems). The locating current pulse generated by the ISOMETER® isoMED427P or the locating current injector PGH are detected using the integrated measuring current transformers and evaluated by insulation fault locators. The integration of six measuring current transformers in an EDS151 permits all current-carrying conductors of an outgoing line to be routed through. The response time for an alarm message inclusively indication on the respective display device is max. 8 s (e.g. MK2430/MK800). A total of 88 EDS151 devices can be connected via an RS-485 interface (BMS protocol). Hence, up to 528 circuits can be monitored. Activities on the BMS bus are indicated by an alarm LED.

### Device features

- Insulation fault location in AC, AC/DC and DC IT systems
- 6 measuring channels with measuring current transformer per EDS151
- Up to 528 measuring channels can be combined by the BMS bus in the IT system being monitored: 88 x 6 measuring channels
- Response sensitivity EDS151: 0.5 mA
- A response time of up to 8 s in the AC system acc. to IEC 61557-9
- RS-485 interface with BMS protocol
- BMS address range 3...90
- Cyclical self test

### Standards

The ISOSCAN® EDS151 complies with the requirements of the device standards: IEC 61557-9.

### Ordering details

Supply voltage $U_s$		Type	Art. No.
AC	DC		
17...24 V, 50...60 Hz	14...28 V	EDS151	B 9108 0101

### Suitable system components

Type designation	Type	Art. No.
Power supply unit	AN450	B 924 201

# EDS461 – Insulation fault location system

Basically, every EDS461 system consists of the following components: the PGH test device, the MK2430 control and indicating device, and one or several EDS461-L-2 insulation fault locators with the accompanying measuring current transformers. Information exchange between the EDS461-L-2 insulation fault locators and the remote alarm indicator and test combination MK2430 takes place via a two wire connection.



ISOSCAN® EDS461-L-2



W10/8000

## EDS461-L:

Together with the measuring current transformer the EDS461-L is used to evaluate locating current signals generated by the PGH.

The device subsequently evaluates the signals from all connected measuring current transformers. If the fault current detected by a measuring current transformer exceeds the response value, the respective alarm LED of the LED line and the alarm LED on the EDS461-L lights up and the alarm relay switches.

Up to 12 measuring current transformer can be connected to each EDS461-L.

All settings within the EDS system are carried out via the bus at the remote alarm indicator and test combination MK2430, TM control panel or COM4651P.

## W10/8000:

The measuring current transformer W10/8000 (internal diameter 10 mm) is a highly sensitive current sensor and converts even very small locating currents into evaluable signals. Connection to the EDS461 is carried out via two connecting leads.

## W10/8000-6:

W10/8000-6 contains 6 W10/8000 on a plastic strip for monitoring closely to clipped-on DIN rail circuit breakers.

## Standards:

The EDS461 system fulfills the requirements of IEC 61557-9: 1999-09: Electrical safety in low voltage distribution systems up to AC 1000 V and DC 1500 V – Equipment for testing, measuring or monitoring of protective measures – Part 9: Equipment for insulation fault location in IT systems.

## Ordering details

Supply voltage $U_s$		Type	Art. No.
AC/DC	AC		
–	16...72 V, 42...460 Hz	EDS461-L-1	B 9108 0007
70...276 V	42...460 Hz	EDS461-L-2	B 9108 0008
–	–	W10/8000	B 911 759
–	–	W10/8000-6	B 911 900

# Power supply units



**AN450**

## **AN450**

The power supply unit AN450 is designed to supply Bender devices with a supply voltage of AC 20 V and a total power consumption of maximum 9 VA.

A maximum of 3 alarm indicator and test combinations MK2430/ MK800 or 6 EDS151 insulation fault locators can be supplied, for example.

### **Standards:**

The AN450 series complies with the requirements of the device standards:

DIN EN 61558-1 (VDE 0570-1) and IEC 61558-1.

## **Ordering details**

Output voltage		Type	Art. No.
DC	AC		
-	20 V, 50...60 Hz	AN450	B 924 201

# Wiring diagram – Insulation fault location system

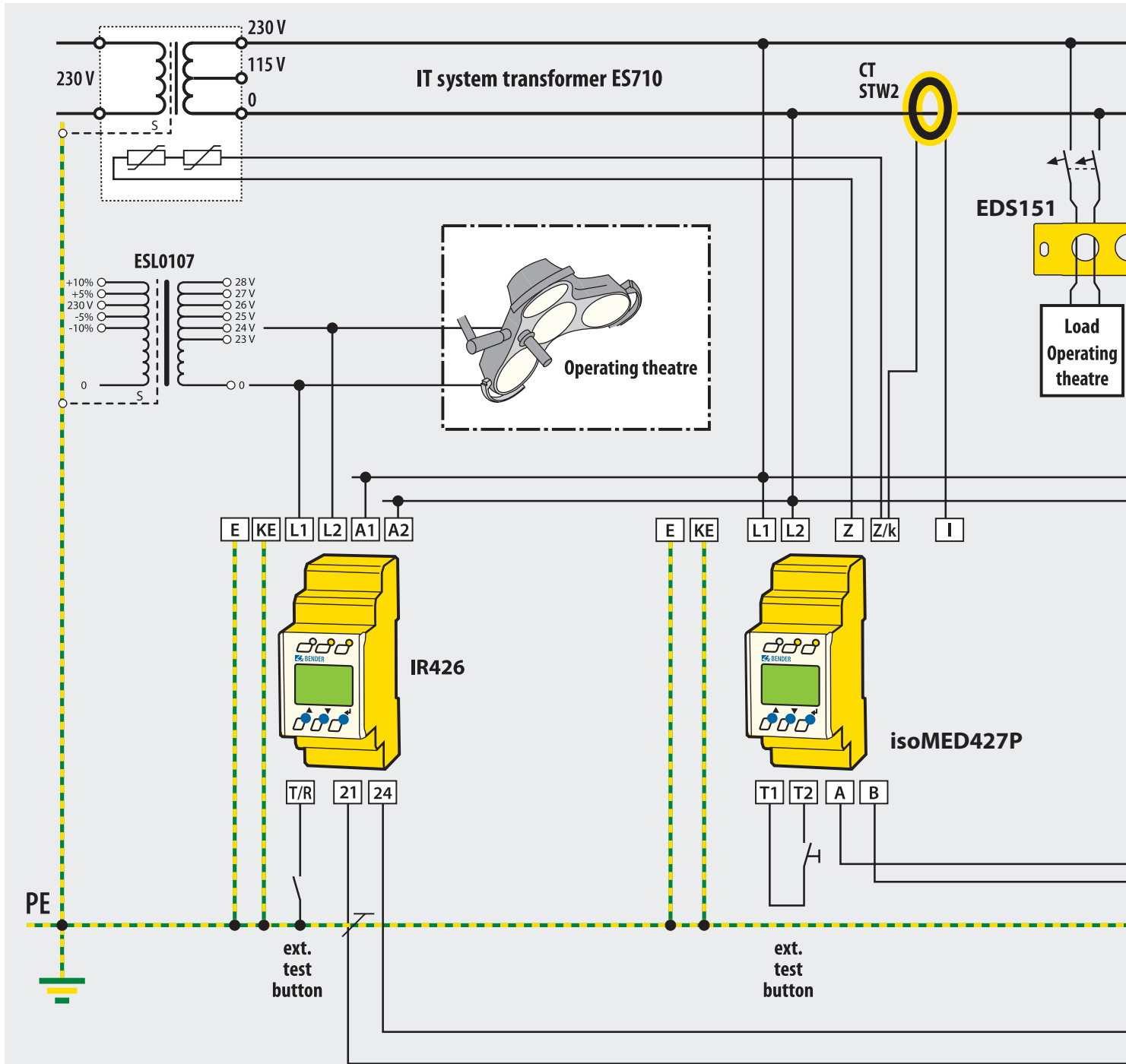

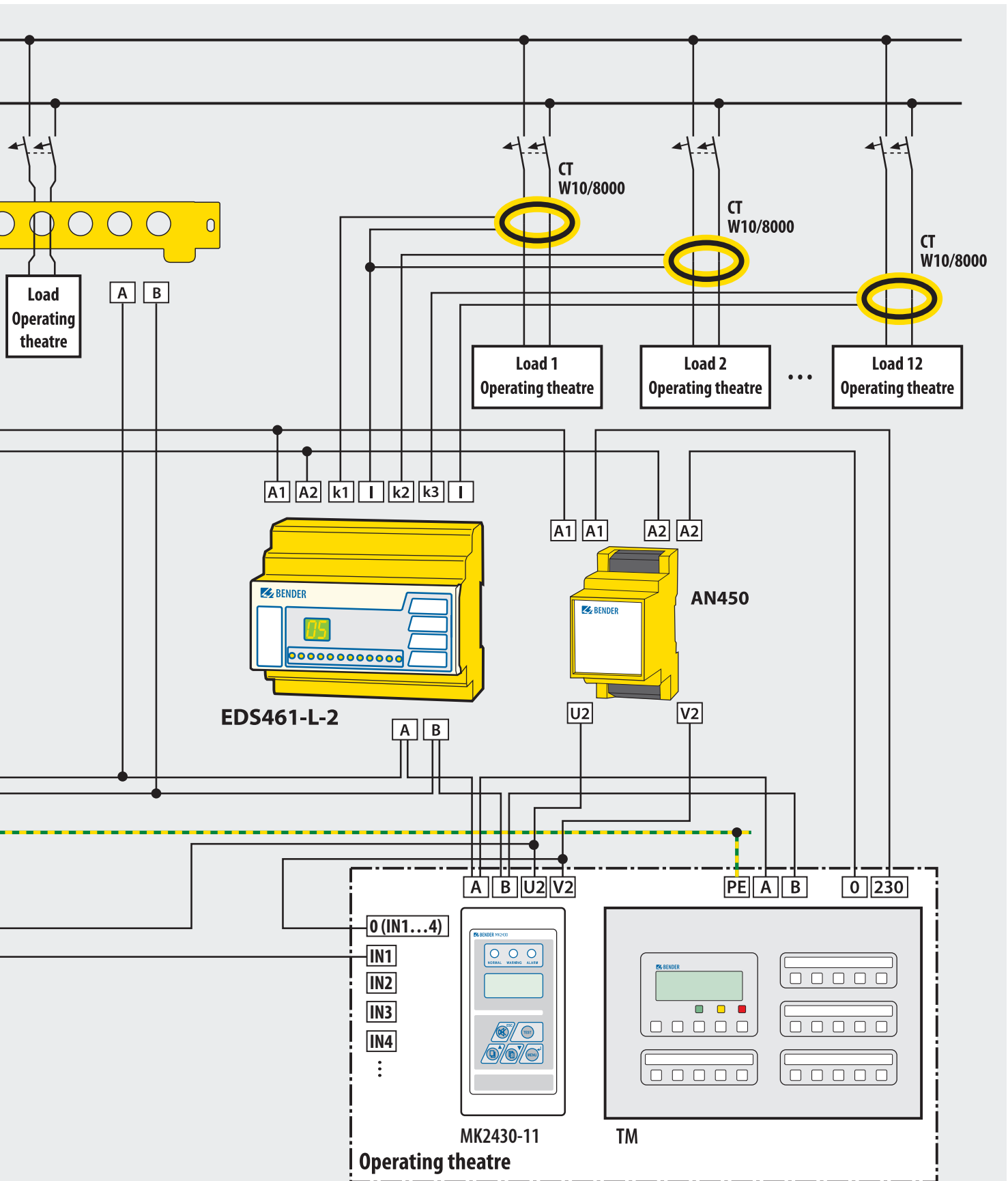

# ES710 – Single-phase isolating transformer

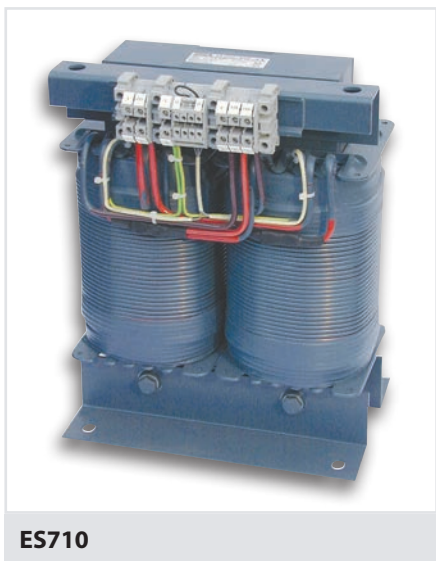

ES710

Isolating transformers of the ES710 series for the power supply of single-phase IT systems in accordance with IEC 60364-7-710: 2002-11 and DIN VDE 0100-710 (VDE 0100-710): 2002-11. A static screen is installed between the primary and secondary windings, which is connected to an isolated terminal. The mounting angles are isolated from the transformer core.

### Features:

- The single-phase isolating transformers meet the requirements of the following standards: IEC 60364-7-710: 2002-11, DIN VDE 0100-710: 2002-11, IEC 61558-1: 1997, DIN EN 61558-1 (VDE 0570-1): 1998, IEC 61558-2-15: 1999, DIN EN 61558-2-15 (VDE 0570-2-15): 2001.
- Rated power 3.15...10 kVA
- Built-in temperature sensors
- Low noise level < 35 dB (A)
- High overload capability
- VDE ENEC mark



Type series

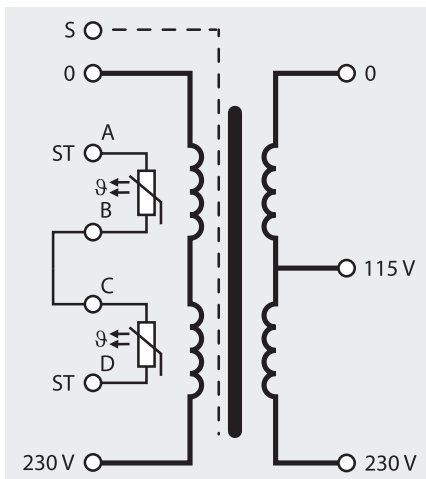

Wiring diagram ES710

### Technical data:

Primary voltage	AC 230 V
Secondary voltage	AC 230 V
Frequency	50...60 Hz
Operating mode	continuous operation
Insulation class	B
Max. ambient temperature	40 °C
Protection class	IP 00
Connections	separate terminal block
Protection class	Class I
PTC resistor	1 resistor per transformer winding

### Dimensions, weight, ordering details

Nominal power kVA	Measures in mm							Total weight kg	Type	Art. No.
	A	B	C	D	E	F	G			
3.15	240	230	325	200	200	160	11	49	ES710/3150	B 924 211
4	280	220	370	240	190	150	11	59	ES710/4000	B 924 212
5	280	230	370	240	200	160	11	61	ES710/5000	B 924 213
6.3	280	245	370	240	215	175	11	65	ES710/6300	B 924 214
8	280	260	370	240	230	190	11	74	ES710/8000	B 924 215
10	320	280	420	270	233	193	13	85	ES710/10000	B 924 216

### Enclosures for transformers

Measures in mm								Total weight kg	Type	Art.-No.
A	B	C	D	E	F	G	H			
430	380	500	385	420	450	∅ 37.5	∅ 20.5	16	ESDS0107-1	B 924 673



# DS0107 – Three-phase isolating transformer

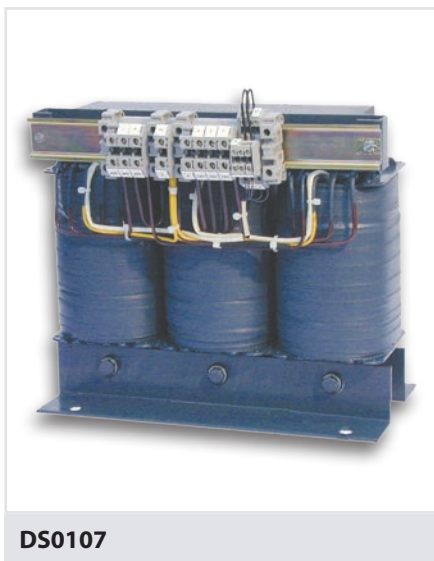

DS0107

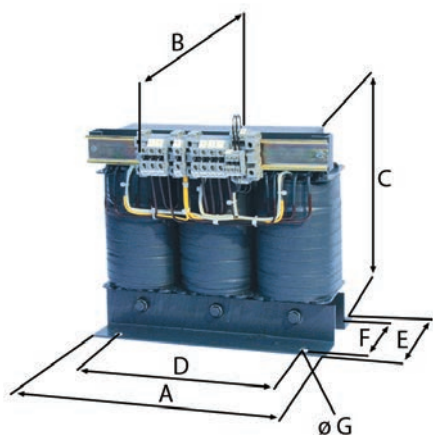

Isolating transformers of the DS0107 series for the power supply of three-phase IT systems in accordance with IEC 60364-7-710: 2002-11 and DIN VDE 0100-710 (VDE 0100 Teil 710): 2002-11. A static screen is installed between the primary and secondary windings, which is connected to an isolated terminal. The mounting angles are isolated from the transformer core.

### Features:

- The three-phase isolating transformers meet the requirements of the following standards: IEC 60364-7-710: 2002-11, DIN VDE 0100-710: 2002-11, IEC 61558-1: 1997, DIN EN 61558-1 (VDE 0570-1): 1998, IEC 61558-2-15: 1999, DIN EN 61558-2-15 (VDE 0570-2-15): 2001.
- Rated power 3.15...10 kVA
- Built-in temperature sensors

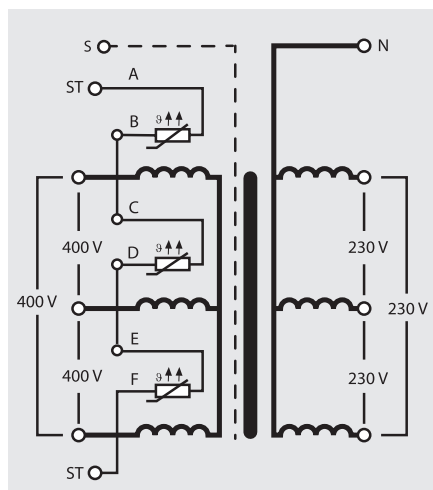

Wiring diagram DS0107

### Technical data:

Primary voltage	3AC 400 V
Secondary voltage	3NAC 230/127 V
Frequency	50...60 Hz
Operating mode	continuous operation
Insulation class	B
Max. ambient temperature	40 °C
Protection class	IP 00
Connections	separate terminal block
Protection class	Class I
PTC resistor	1 resistor per transformer winding

### Dimensions, weight, ordering details

Nominal power kVA	Measures in mm							Total weight kg	Type	Art.-No.
	A	B	C	D	E	F	G			
3.15	360	210	325	310	170	135	11	63	DS0107/3150	B 924 106
4	360	225	325	310	185	150	11	70	DS0107/4000	B 924 121
5	360	240	325	310	200	165	11	77	DS0107/5000	B 924 112
6.3	420	230	370	370	200	160	11	97	DS0107/6300	B 924 107
8	420	245	370	370	215	175	11	107	DS0107/8000	B 924 628
10	420	260	370	370	230	190	11	130	DS0107/10000	B 924 672

### Enclosures for transformers

Measures in mm								Total weight kg	Type	Art.-No.
A	B	C	D	E	F	G	H			
430	380	500	385	420	450	∅ 37.5	∅ 20.5	16	ESDS0107-1	B 924 673 <sup>1)</sup>
600	420	490	555	460	490	∅ 50.5	∅ 20.5	23	ESDS0107-2	B 924 674 <sup>2)</sup>

<sup>1)</sup> for DS0107/3150...DS0107/5000 – <sup>2)</sup> for DS0107/6300...DS0107/10000

# LINETRAXX® Power Quality and Energy Measurement

## For transparency in electrical installations



Power Quality and Energy Measurement



COMTRAXX® CP700

### Monitoring of the power quality and collection of relevant data for energy management systems.

The digital universal measuring devices PEM are suited for recording and displaying electrical parameters of electricity networks. The scope of measurements ranges from currents and voltages through energy consumption and performance to total harmonic distortion for voltage quality assessment.

### Condition Monitor

Supply voltage/ frequency range $U_s$	Power consumption	Type	Art. No.
DC 24V/± 25 %	typ. 11 W/max. 26 W	CP700	B 9506 1030

### Convincing benefits:

The collection and evaluation of the measurement parameters is carried out by the Condition Monitor COMTRAXX® CP700.

- A platform for unified operation and parameterisation of a wide variety of devices.
- Intuitive use
- Interactive help systems instead of operating manuals.
- Automatic adaptation to your installation.
- Guided support in fault analysis and for immunisation.
- User-defined filtering of the relevant information.

Digital inputs/outputs	Nominal system voltage	Interface		Current input	Type	Art. No.
		Modbus RTU	Modbus TCP			
–	3(N)AC 230/400 V	–	–	5 A	PEM330	B 9310 0330
				1 A	PEM330-251	B 9310 0331
2/2	3(N)AC 230/400 V	■	–	5 A	PEM333	B 9310 0333
				1 A	PEM333-251	B 9310 0334
2 pulse outputs (kWh/kvarh)	3(N)AC 230/400 V	■	–	5 A	PEM333-255P	B 9310 0335
				1 A	PEM333-251P	B 9310 0336
6/2	3(N)AC 230/400 V	■	–	5 A	PEM533	B 9310 0533
				1 A	PEM533-251	B 9310 0534
	3(N)AC 400/690 V	■	–	5 A	PEM533-455	B 9310 0535
				1 A	PEM533-451	B 9310 0536
6/3	3(N)AC 230/400 V	■	■	5 A	PEM555	B 9310 0555
				1 A	PEM555-251	B 9310 0556
6/3	3(N)AC 400/690 V	■	■	5 A	PEM555-455	B 9310 0557
				1 A	PEM555-451	B 9310 0558
6/3	3(N)AC 230/400 V	■	■	5 A	PEM575	B 9310 0575
				1 A	PEM575-251	B 9310 0576
	3(N)AC 400/690 V	■	■	5 A	PEM575-455	B 9310 0577
1 A				PEM575-451	B 9310 0578	
8/3	3(N)AC 100...690 V	■	■	1/5 A	PEM735	B 9310 0735

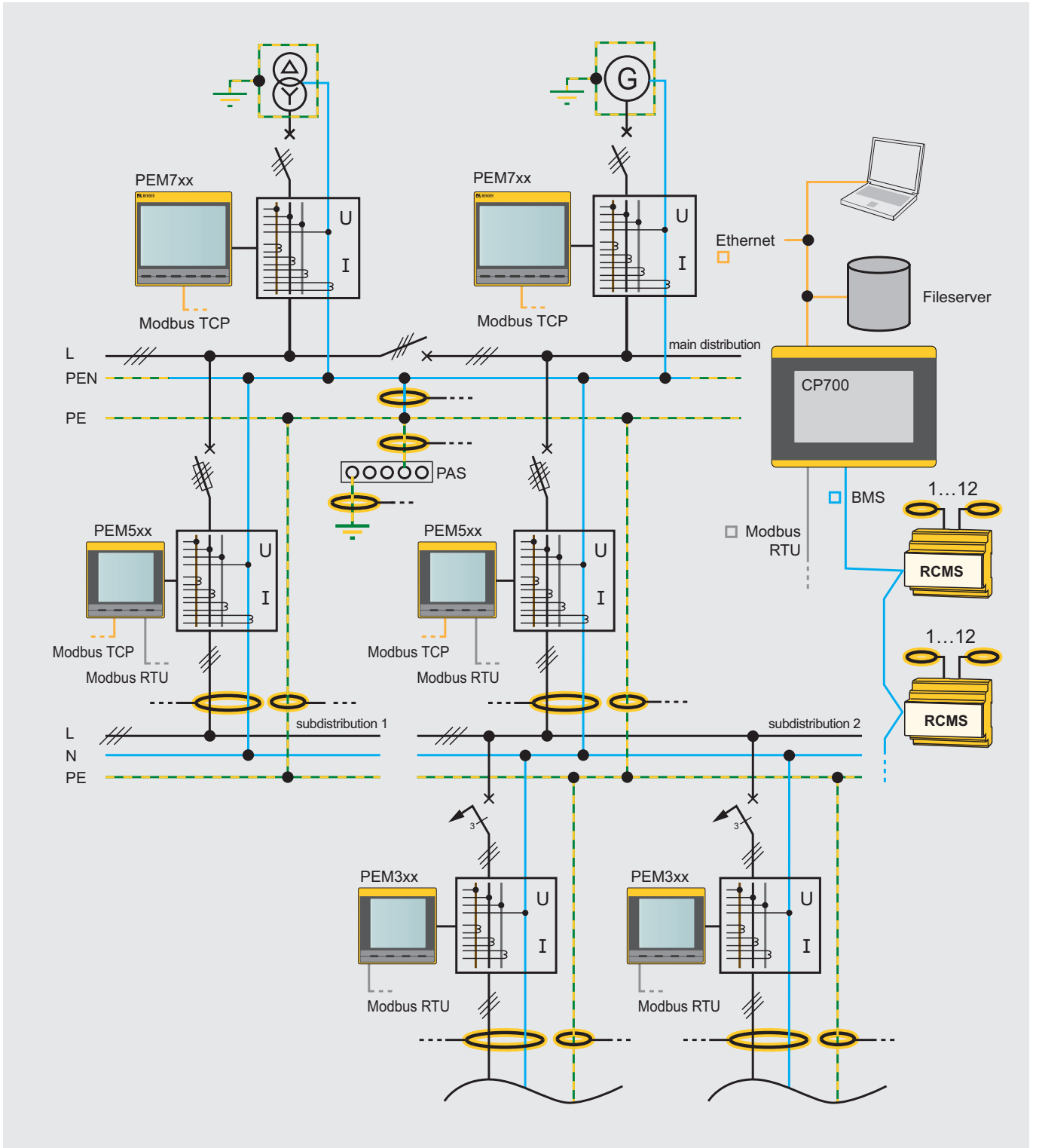

Application diagram LINETRAXX®

# Communication solutions



**Ethernet gateway COMTRAXX® COM465IP**

The COM465IP is a Condition Monitor with gateway that converts data from the Bender system into the Modbus TCP protocol. The integrated web interface gives a perfect overview of the data from Bender systems on any personal computer, tablet or smartphone. Additional software installation is not required.

## Features

- Condition Monitor for Bender systems
- Integrated modular gateway between Bender systems and TCP/IP enables remote access via LAN, WAN or the Internet
- Range of functions adjustable through function modules
- Ethernet (10/100 Mbit/s) for remote access via LAN, WAN or the Internet
- Support of devices connected to the internal or external BMS bus via BCOM, Modbus RTU or Modbus TCP

## Your advantages

- Bidirectional Modbus TCP gateway
- Fast, simple parameter setting of all devices in the Bender system using a web browser
- Assignment of system-specific text codes for devices and measurement points
- E-mail notifications for alarms and system faults to different user groups
- Device failure monitoring
- Report function stores measured values and settings. Saved settings can be used for parameterisation of other devices. This means comparing previous and current settings is very simple and clear
- Fast, clear visualisation without requiring special programming skills to set it up. For example, measurements or alarms can be arranged and displayed on a building plan. Links along with the alarm status of the devices contained therein can be inserted into the different views

## Visualisation example COM465IP and optional package D

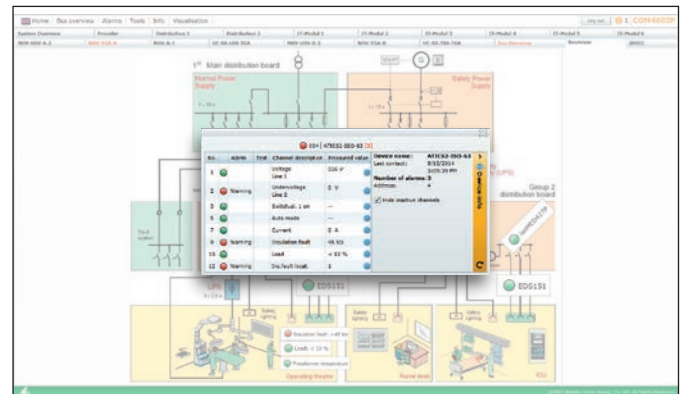

## Web overview

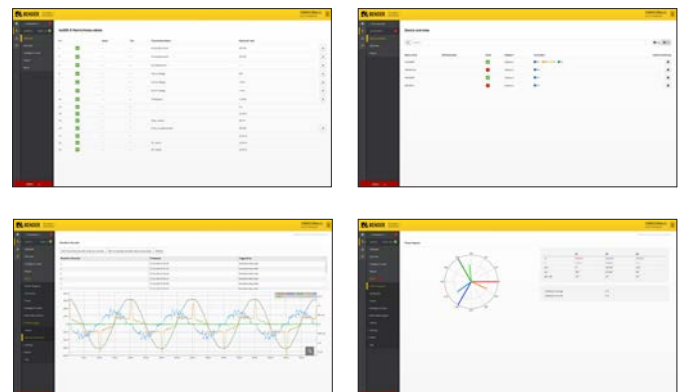

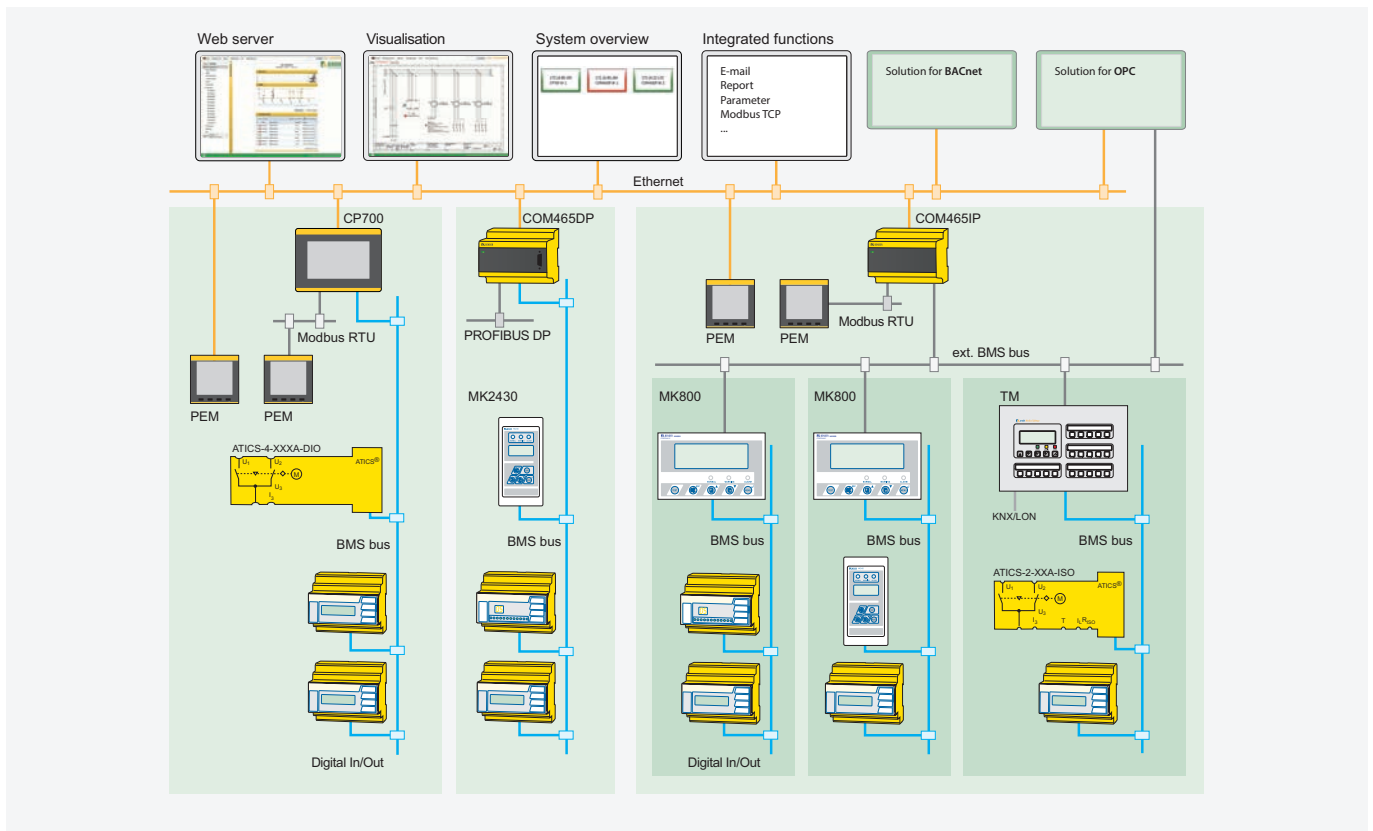

Communication possibilities with Bender systems and devices

## Ordering information

Supply voltage/frequency range $U_s$		Power consumption	Application	Type	Art. no.
AC/DC	DC				
24...240 V, 50...60 Hz	–	$\leq 6.5 \text{ VA} / \leq 4 \text{ W}$	Condition Monitor with integrated gateway: Bender system/Ethernet	COM465IP-230V	B95061065
–	24 V	$\leq 3 \text{ W}$		COM465IP-24V	B95061066
24...240 V, 50...60 Hz	–	$\leq 6.5 \text{ VA} / \leq 4 \text{ W}$	Condition Monitor with integrated gateway: Bender system / PROFIBUS DP / Ethernet	COM465DP-230V	B95061060
–	24 V	$\leq 3 \text{ W}$		COM465DP-24V	B95061061

## Optional package

Application	Function module (software licence)	Art. no.
Individual text messages for all devices/channels, device failure monitoring, e-mail in the event of an alarm	Function module A	B 7506 1011
Modbus TCP server for max. 98 * 139 BMS nodes as well as BCOM and universal measuring devices, SNMP server	Function module B	B 7506 1012
Parameter setting of BMS devices as well as BCOM and universal measuring devices	Function module C	B 7506 1013
Visualisation of Bender systems, system visualisation	Function module D	B 7506 1014
Virtual devices	Function module E	B 7506 1015
Integration of third-party devices	Function module F	B 7506 1016

# Some references for hospital equipment (Europe)

Country	City	Name
Austria	▶ Bregenz	▶ Landeskrankenhaus Bregenz
		▶ Eisenstadt
	▶ Graz	▶ LKH-Universitätsklinikum Graz
	▶ Innsbruck	▶ Universitätsklinikum Innsbruck
	▶ Klagenfurt	▶ Landeskrankenhaus Klagenfurt
	▶ Linz	▶ Allgemeines Krankenhaus der Stadt Linz
		▶ Unfallkrankenhaus Linz
		▶ Landes-Frauen- und Kinderklinik
		▶ Landes-Nervenklinik Wagner Jauregg
		▶ Allgemein öffentliches Krankenhaus Elisabethinen Linz
	▶ Salzburg	▶ Universitätsklinikum Salzburg
▶ Spittal/Drau	▶ A.ö.Krankenhaus Spittal/Drau	
▶ St. Pölten	▶ Landesklinikum St. Pölten	
▶ Wien	▶ Allgemeines Krankenhaus der Stadt Wien	
	▶ Krankenhaus Göttlicher Heiland	
	▶ Unfallkrankenhaus Meidling	
▶ Wr. Neustadt	▶ Sozialmedizinisches Zentrum Ost – Donauespital	
	▶ Landesklinikum Wr. Neustadt	
Belorussia	▶ Gomel	▶ Cardiological Center
	▶ Minsk	▶ Clinical City Hospital No. 10
		▶ Republican Hospital
		▶ Transplantology Center of the Belorussian Public Health Ministry
Croatia	▶ Split	▶ Medical Centre
	▶ Zagreb	▶ Medical Centre
	▶ Karlovac	▶ General Hospital
	▶ Virovitica	▶ General Hospital
	▶ Osijek	▶ General Hospital
	▶ Zagreb	▶ Children's Hospital
Czech Republic	▶ Brno	▶ Faculty Hospital Brno Bohunice
		▶ St. Anne's university hospital Brno
	▶ Hradec Králové	▶ Faculty Hospital Hradec Králové
	▶ Jihlava	▶ Hospital Jihlava
	▶ Karlovy Vary	▶ Hospital Karlovy Vary
	▶ Nový Jičín	▶ Hospital Nový Jičín
	▶ Prag	▶ FN Motol University Hospital



Motol Hospital

Country	City	Name
Estonia	▶ Kohtla-Järve	▶ Ida-Viru Keskhaigla
	▶ Tallinn	▶ Põhja-Eesti Regionaalhaigla
	▶ Tartu	▶ Ida-Tallinna Keskhaigla ▶ Tartu Ülikooli Kliinikum
Germany	▶ Berlin	▶ Charite – Virchow Klinikum Berlin
	▶ München	▶ Uniklinikum München-Groshadern
	▶ Hamburg	▶ Unfallkrankenhaus Eppendorf-Hamburg
	▶ Dresden	▶ Universitätsklinikum Dresden
	▶ Hannover	▶ Medizinische Hochschule Hannover
	▶ Magdeburg	▶ Uniklinikum Magdeburg
	▶ Würzburg	▶ Klinikum Würzburg
Lithuania	▶ Joniskis	▶ Joniskis Hospital
	▶ Klaipeda	▶ Republic Hospital Klaipeda
	▶ Siauliai	▶ Siauliai Surgery Centre
	▶ Vilnius	▶ Children's Hospital of Santariskiu Klinikos
Norway	▶ Bergen	▶ Helse Bergen HF Haukeland Universitetssykehus
		▶ Nordlandssykehuset HF
	▶ Bødø	▶ Vestre Viken HF Sykehuset Buskerud
	▶ Drammen	▶ Sørlandets Sykehus HF Kristiansand
	▶ Oslo	▶ Oslo Universitetssykehus HF, Rikshospitalet
		▶ Oslo Universitetssykehus HF, Radiumhospitalet
		▶ Oslo Universitetssykehus HF, Ullevål
▶ Oslo Universitetssykehus HF, Aker		
	▶ Akershus Universitetssykehus HF	
▶ Stavanger	▶ Helse Stavanger HF	
▶ Tønsberg	▶ Sykehuset Vestfold HF	
▶ Trondheim	▶ St Olavs Hospital HF	
Poland	▶ Białystok	▶ Uniwersytecki Szpital Kliniczny
	▶ Bydgoszcz	▶ Szpital Wojskowy
	▶ Gdańsk	▶ Centrum Medycyny Inwazyjnej UMG
	▶ Jarocin	▶ Szpital Powiatowy
	▶ Lublin	▶ SPK nr 4
	▶ Szczecin-Zdunowo	▶ Szpital Specjalistyczny
	▶ Warszawa	▶ Szpital im. Św. Rodziny
		▶ Szpital Praski
		▶ Instytut Gruźlicy i Chorób Płuc
		▶ Wojskowy Instytut Medyczny
▶ Zabrze	▶ Śląskie Centrum Chorób Serca	
▶ Żary	▶ 105. Szpital Wojskowy	
Russia	▶ Krasnodar	▶ Prof. Ochapovski Regional Clinical Hospital No. 1
	▶ Moskow	▶ Russian Children's Clinical Hospital
		▶ Center for Sport and Ballet Traumatology and Rehabilitation
		▶ Clinical City Hospital No. 12
		▶ Bakulev Scientific Center for Cardio-vascular Surgery
		▶ Pirogov National Medicosurgical Center
		▶ Clinical City Hospital No. 81
	▶ St.-Petersburg	▶ Regional Clinical Hospital
		▶ Onkology Hospital, Pesotchni Settlement

Country	City	Name
Slovak Republic	▶ Banská Bystrica	▶ Faculty Hospital with policlinic F.D. Roosevelta
	▶ Dunajská Streda	▶ Hospital Dunajská Streda
	▶ Prešov	▶ Faculty hospital Prešov
	▶ Ružomberok	▶ Hospital Ružomberok
	▶ Žilina	▶ Hospital with policlinic Žilina
Slovenia	▶ Ljubljana	▶ University Medical Centre ▶ Institute of Oncology ▶ Children's Hospital
	▶ Maribor	▶ University Medical Centre
	▶ Celje	▶ General Hospital
	▶ Slovenj Gradec	▶ General Hospital
	▶ Jesenice	▶ General Hospital
	▶ Murska sobota	▶ General Hospital
	▶ Brežice	▶ General Hospital
	Sweden	▶ Karlstad
▶ Linköping		▶ TMC – Linköping Universitetet
▶ Göteborg		▶ BIOC Bild och interventionscentrum ▶ Angereds närsjukhus
▶ Örebro		▶ USÖ – Universitetssjukhuset i Örebro ▶ Örebro Sjukhus
▶ Jönköping		▶ Länsjukhuset Ryhov
▶ Lindesberg		▶ Lindesbergs lasarett
▶ Sundsvall		▶ Sundsvalls Sjukhus. Operation
▶ Norrköping		▶ Vrinnevisjukhuset
Switzerland		▶ Basel
	▶ Luzern	▶ Luzerner Kantonsspital ▶ Hirslanden Klinik St. Anna
	▶ Bern	▶ Inselspital Bern
	▶ Grabs	▶ Spital Grabs
	▶ Männedorf	▶ Spital Männedorf
	▶ Winterthur	▶ Kantonsspital Winterthur
	▶ Zürich	▶ Universitätsspital Zürich
UK	▶ London	▶ Royal Free Hospital
	▶ Newcastle	▶ Newcastle Royal Infirmary
	▶ Edinburgh	▶ Royal Infirmary of Edinburgh
	▶ Birmingham	▶ Birmingham PFI Hospital ▶ Good Hope Hospital
	▶ Liverpool	▶ Alder Hey Hospital ▶ Liverpool Heart & Chest Hospital
	▶ Barrow-in-Furness	▶ Furness General Hospital
	▶ Manchester	▶ Manchester Royal Infirmary
▶ Brighton	▶ Royal Sussex County Hospital	

## Some references for hospital equipment (South and North America)

Country	City	Name
Argentina	▶ Buenos Aires	▶ Hospital Británico
		▶ Sanatorio Mater Dei
		▶ Hospital Aleman
Brazil	▶ Altamira	▶ Hospital Geral De Altamira
	▶ Belo Horizonte	▶ Santa Casa De Misericordia De Belo Horizonte
	▶ Brasilia	▶ Hospital Daher Lago Sul
	▶ Campo Grande	▶ Hospital Regional Do Mato Grosso Do Sul
	▶ Juazeiro Do Norte	▶ Hospital Regional Do Cariri
	▶ Manaus	▶ Hospital Nilton Lins
	▶ Recife	▶ Hospital Geral Jayme Da Fonte
	▶ Rio De Janeiro	▶ Hospital Das Americas
		▶ Hospital Quinta D'or
		▶ Hospital Aliança
	▶ São Luiz	▶ Hospital Dr Carlos Macieira
	▶ São Paulo	▶ Hospital Sirio Libanes
		▶ Hospital Israelita Albert Einstein
▶ Teresina	▶ Hospital Universitario Do Piaui	
▶ Vitoria	▶ Hospital Dorio Silva	

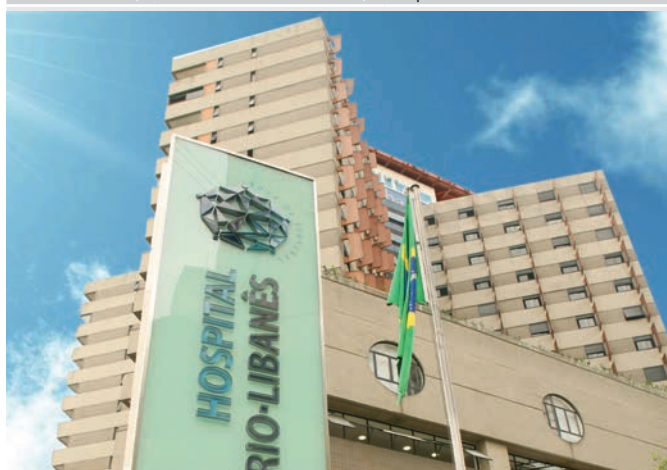

Hospital Sirio Libanes

Canada	▶ Toronto, ON	▶ Sick Kids Hospital*
		▶ St. Michaels Hospital*
	▶ Edmonton, AB	▶ Grey Nuns Hospital*
	▶ Vancouver, BC	▶ Vancouver General Hospital*
	▶ Oakville, ON	▶ Oakville General Hospital*
	▶ Kingston, ON	▶ Hotel Dieu Hospital*
▶ Fort McMurray, AB	▶ Northern Lights Health Ctr.*	
	▶ Montréal, QC	▶ Hopital du Sacre Coeur de Montréal*
Colombia	▶ Bogotá	▶ Clínica Fundación Santa Fe*
		▶ Clínica La Colina Bogotá*
	▶ Ibagué	▶ Clínica Los Nogales Ibagué*
Costa Rica	▶ San Jose	▶ Hospital San Juan de Dios*
	▶ Siquirres	▶ CENTRO DE ATENCION INTEGRAL DE SALUD DE SIQUIRRES*
Dominican Republic	▶ Santo Domingo	▶ CEDIMAT PROJECT*
Ecuador	▶ Guayaquil	▶ Omni Hospital, Guayaquil*
	▶ Loja	▶ Hospital Catacocha*
	▶ Quito	▶ Hospital de Los Valles*
El Salvador	▶ San Salvador	▶ HOSPITAL MATERNIDAD*

Country	City	Name
Guatemala	▶ Guatemala City	▶ Hospital de Villanueva*
	▶ Chimaltengano	▶ HOSPITAL CHIMALTENGANO*
	▶ Coatepeque	▶ HOSPITAL COATEPEQUE*
	▶ Mazatenango	▶ HOSPITAL DE MAZATENANGO*
Nicaragua	▶ Managua	▶ HOSPITAL METROPOLITANO VIVIAN PELLAS*
Panama	▶ Panama City	▶ Hospital UCI Adultos y Neomatos*
Peru	▶ Lima	▶ Clínica san Borja Internacional
		▶ Clínica San Judas Tadeo
USA	▶ New York, NY	▶ NYU Hospital Center Helen L and Martin S Kimmel Pavilion *
		▶ Seattle, WA
	▶ Ann Arbor, MI	▶ University of Michigan Medical Center*
	▶ Nashville, TN	▶ Vanderbilt University Medical Center*
	▶ Philadelphia, PA	▶ Hospital of the University of Pennsylvania*
Venezuela	▶ Cagua	▶ Centro Médico Cagua
	▶ Caracas	▶ Clínica Sanitas
	▶ Caracas	▶ Clínica La Urbina
	▶ Pto. Cabello	▶ Clínica San Jose
	▶ San Cristóbal	▶ Policlínica Táchira

\*NFPA99



# Some references for hospital equipment (Middle East, Africa)

Country	City	Name
Bahrain	▶ Manama	▶ BAHRAIN DEFENCE FORCE HOSPITAL
Egypt	▶ Cairo	▶ Dar El Fouad
		▶ El Galaa Hospital
		▶ Egypt Air hospital
		▶ Al Salam international hospital
		▶ Wadi Al Neel hospital
		▶ Police Hospital Cairo
		▶ Arab contractor Medical Center
		▶ Dar Al Oyoum Hospital
		▶ Asfour Charity Hospital
		▶ Kobri El Koba Hospital
▶ Dar Al Fouad Hospital Nasr City*		
▶ As-Salam International Hospital*		
▶ Al Azhar University*		
▶ Mansoura	▶ Mansoura University	
▶ El Monofeya	▶ El Araby International Hospital	
▶ Alexandria	▶ Police Hospital Alexandria	



*Al Salam international hospital*

Kuwait	▶ KUWAIT CITY	▶ SAFAT AMERICAN HOSPITAL	
QATAR	▶ DOHA	▶ HAMAD BIN KHALIFA MEDICAL CITY	
		▶ HAMAD GENERAL HOSPITAL	
		▶ SIDRA MEDICAL AND RESEARCH CENTER	
		▶ HEART HOSPITAL	
		▶ AL RUMAILAH HOSPITAL	
		▶ FALCON CLINIC & HOSPITAL	
		▶ WAKRA HOSPITAL	
		▶ QATAR ORTHOPEDIC	
		▶ DUKHAN	▶ CUBAN HOSPITAL



*Aspetar*

Country	City	Name	
Saudi-Arabia	▶ Dammam	▶ Maternity and Children Hospital	
	▶ Al Khobar	▶ King Fahd Teaching Hospital	
	▶ Makkah and Riyadh	▶ King Faisal Hospital	
	▶ Najran	▶ Inha University Hospital King Faisal Hospital*	
	▶ Riyadh	▶ Prince Sultan Cardiac Center King Saud Bin Abdulaziz University Hospital ▶ Princess Noura University Hospital North Riyadh Hospital – 300 Bed* King Khaleed Hospital* Prince Salman Hospital*	
	▶ Tabuk	▶ Tabuk Military Hospital*	
	▶ Jeddah	▶ King Fahd Hospital*	
	UAE	▶ ABU DHABI	▶ ETIHAD AIRWAYS EMERGENCY RESPONSE CENTER
			▶ GDC HOSPITAL
			▶ AL NOOR HOSPITAL
▶ AL RAHBA HOSPITAL			
▶ SHEIKH KHALIFA MEDICAL CITY			
▶ AL AIN		▶ AL AIN JIMI HOSPITAL ▶ TAWAM HOSPITAL	
▶ Dubai		▶ ZAHRA MEDICAL CENTER ▶ JALILA CHILDREN SPECIALTY HOSPITAL	
▶ FUJAIRAH		▶ FUJAIRAH HOSPITAL	
▶ SILAA		▶ SILAA COMMUNITY HOSPITAL	



*AL NOOR HOSPITAL*

\*NFPA99

# Some references for hospital equipment (Asia Pacific, Asia)

Country	City	Name
China	▶ Beijing	▶ Peking Union Medical College Hospital
		▶ Fuwai Hospital Organization
		▶ Beijing Anzhen Hospital
	▶ Changchun	▶ The 1st Hospital of JiLin University
	▶ Changsha	▶ XiangYa Hospital of Central South University
	▶ Fuzhou	▶ Fujian Provincial Hospital
	▶ Guangzhou	▶ The 1st hospital of Guangzhou ZhongShan University
	▶ Hangzhou	▶ The 2nd hospital of ZheJiang University
	▶ Jinan	▶ Shandong provincial hospital
		▶ JiNan Military General Hospital
	▶ Nanchang	▶ The JiangXi Provincial people's hospital
	▶ Shanghai	▶ Zhangshan Hospital Fudan University
		▶ Ruijin Hospital of Jiaotong University
		▶ TongJi Hospital, TongJi medical college of hust
	▶ Shenzhen	▶ Shenzhen People's Hospital
		▶ Haibin Hospital of HongKong University
	▶ Tianjin	▶ Hospital of TianJin Medical University
▶ Wenzhou	▶ The 1st hospital of WenZhou Medical University	
▶ Wuhan	▶ Hebei Provincial People's Hospital	
▶ Zhengzhou	▶ Henan Provincial People's Hospital	



Beijing Union Medical College Hospital

Hong Kong	▶ Hong Kong	▶ Union Hospital
		▶ Queen Elizabeth Hospital
India	▶ Bengaluru	▶ Bhagwan Mahaveer Jain Hospital
	▶ Bhubaneswar	▶ Apollo Hospital
	▶ Gurgaon	▶ Medanta
	▶ Jammu	▶ Govt. Medical College & Hospital
	▶ Kochi	▶ Lourdes Hospital
	▶ Lucknow	▶ Ram Manohar Lohia
	▶ Mumbai	▶ Asian Heart Institute
		▶ Harkishan Das Hospital
	▶ Noida	▶ Jaypee Hospital
	▶ Thiruvananthapuram	▶ Regional Cancer Center Hospital
	▶ Thrissur	▶ Govt. Medical College & Hospital

Country	City	Name
Indonesia	▶ Aceh	▶ RS. Umum Daerah Zaenal Abidin
		▶ di Jogyakarta
	▶ Jakarta	▶ Puri Indah Hospital
		▶ Dr. Cipto Mangunkusumo Hospital
		▶ National Brain Center Hospital Cawang
		▶ Siloam MRCC Hospital
		▶ Jakarta Heart Center Hospital
	▶ Kalimantan	▶ RS. Umum Daerah Wahab Syahrani
	▶ Palembang	▶ RS. Umum Moh. Husein
	▶ Riau	▶ Eka Hospital Interational Pekanbaru
	▶ Serpong Tangerang	▶ Eka Hospital
	▶ Tangerang	▶ Omni International Hospital Alam Sutera
	▶ Siquirres	▶ CENTRO DE ATENCION INTEGRAL DE SALUD DE SIQUIRRES
Malaysia	▶ Kuala Lumpur	▶ National Cancer Institute Putrajaya
		▶ General Hospital of Kuala Lumpur
	▶ Malacca	▶ Melaka Straits Medical Centre
	▶ Pahang	▶ Hospital of Islamic International University
	▶ Sabah	▶ Gleneagles Kota Kinabalu
▶ Selangor	▶ Medical Centre of Malaya University	
Mongolia	▶ Ulaanbaatar	▶ International medical center LLC
Pakistan	▶ Karachi	▶ Sindh Institute of Urology and Transplant
	▶ Karachi	▶ Civil Hospital
Republic of Korea	▶ Cheonan	▶ Cheonan Medical Center
	▶ Chuncheon	▶ Kangwon National University Hospital
	▶ Daejeon	▶ Konyang University Hospital
	▶ Incheon	▶ Inha University Hospital
	▶ Jeonju	▶ Chonbuk National University Hospital
	▶ Seogwipo	▶ Seogwipo Medical Center
	▶ Seoul	▶ Seoul National University Hospital
		▶ Seoul Metropolitan Government Seoul National University Boramae Medical Center
		▶ The Catholic University of Korea Seoul St. Mary's Hospital
		▶ Korea University Medical Center
		▶ National Medical Center
▶ National Police Hospital		
▶ Korea Institute of Radiological & Medical Sciences		
▶ Wonju	▶ Severance Hospital	



Gyeongsang National University Hospital

Country	City	Name
Singapore	Singapore	▶ Novena Mount Elisabeth Hospital
		▶ Khoo Teck Puat Hospital
		▶ NUH Medical Centre
		▶ Singapore General Hospital
		▶ Ng Teng Fong Hospital
		▶ NUH Hospital
Taiwan	▶ Taichung	▶ China Medical University Hospital
	▶ Tainan	▶ National Cheng Kung University Hospital
	▶ Taipei	▶ Mackay Memorial Hospital ▶ Tri-Service General Hospital
Thailand	Bangkok	▶ Siriraj Hospital, Mahidol University
		▶ Bangkok Hospital
		▶ Bumrungrad Hospital
		▶ Vichaiyut Hospital
		▶ St. Louis Hospital
		▶ Sukumvit Hospital
		▶ Huachiw Hospital
▶ Veterans General Hospital		
▶ Paolo Memorial Sapankaew		
	▶ Chiangmai	▶ Bangkok Hospital
	▶ Lampang	▶ Lampang Hospital
	▶ Phitsanulok	▶ Bangkok Hospital



*Bangkok Hospital*

Vietnam	▶ An Giang Province	▶ An Giang General Hospital
	▶ Binh Duong	▶ My Phuoc General Hospital
	▶ Binh Duong Province	▶ Hanh Phuc Hospital
	▶ Can Tho City	▶ Can Tho General Hospital
	▶ Da Nang	▶ Family Hospital
	▶ Ha Noi	▶ High Tech Center - Viet Duc Hospital
	▶ HCMC	▶ Hoa Lam Shangrila Hospital ▶ Fortis Hoan My Phan Xich Long Hospital
	▶ Hue	▶ Phong Dien General Hospital



**Bender GmbH & Co. KG**

P.O.Box 1161 • 35301 Gruenberg • Germany  
Londorfer Straße 65 • 35305 Gruenberg • Germany  
Tel.: +49 6401 807-0 • Fax: +49 6401 807-259  
E-mail: [info@bender.de](mailto:info@bender.de) • [www.bender.de](http://www.bender.de)

Photos: Fotolia (© spotmatikphoto), © TRILUX® and Bender archives.



**BENDER Group**